

# FLUSH PLATES

BETTER ON EVERY LEVEL



Ideal Standard

PART OF THE IDEAL STANDARD GROUP

Flush plates

# Contents

**'Whatever your bathroom vision,  
it's the details that make  
the difference.'**

4	MAKING LIFE BETTER FOR OUR CUSTOMERS
6	PERFECT FINISHING
8	OUR TECH, YOUR TOUCH
16	FLUSH PLATES – BATHROOM DESIGN TAKEN TO ANOTHER LEVEL
18	ALTES™ & SYMFO™
24	OLEAS™
34	SOLEA™
44	SEPTA PRO™
72	PROSYS™ INSTALLATION SYSTEMS
76	PROVEN RELIABILITY
77	COMPATIBILITY WITH CISTERNS AND CONVERSION KITS
78	MINIMUM WALL THICKNESS (MM)
80	TECHNICAL INFORMATION



Wall-hung bowl: Esedra  
Flush plate: Solea™ P2 in white



Wall-hung bowl: Connect  
Flush plate: Oleas™ M3/P3 in matt chrome

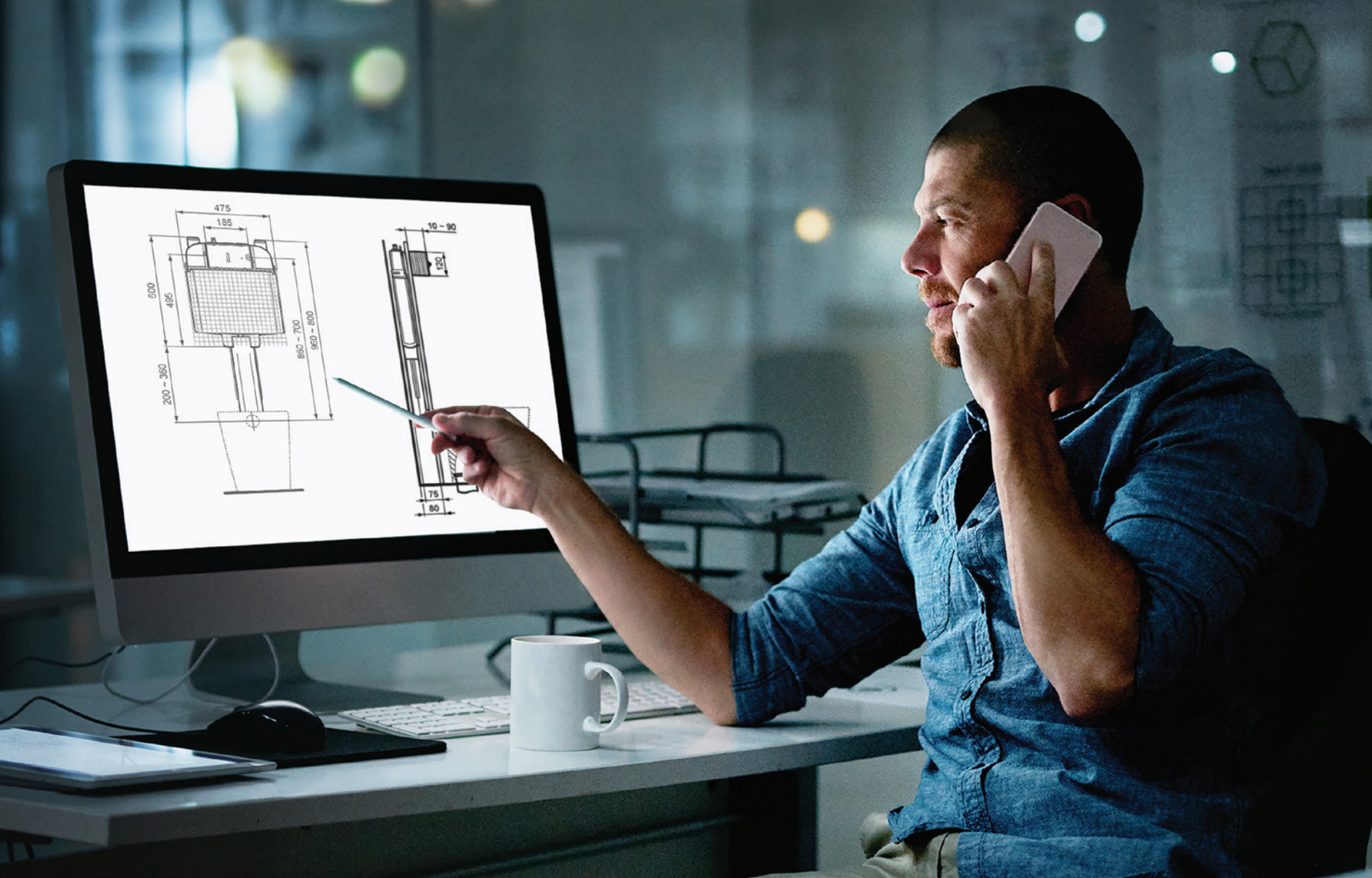

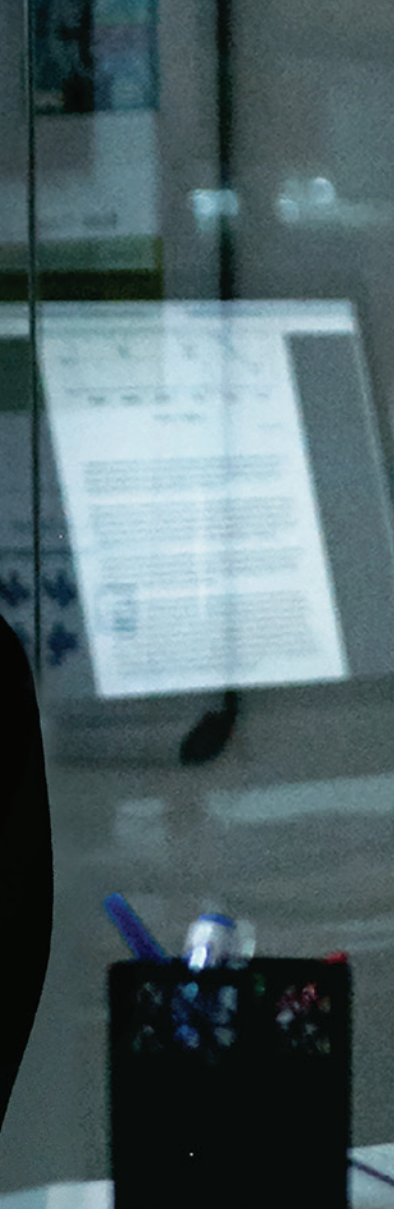

## Making life better for our customers

For over 100 years, our mission has been to make life better for our customers. We do this by bringing emotional meaning to functional perfection: always innovating to anticipate the demands and aspirations of modern living.

From our roots pioneering products like the single lever tap, to delivering solutions for pressing global challenges, we create not just for today, but for tomorrow.

# Perfect finishing



Wall-hung bowl AquaBlade®: Tesi  
Flush plate: Altes™ NT1 in black

Whatever your bathroom vision, it's the details that make the difference. That's why our range of flush plates offers a choice of shapes, colours, functions and materials to meet any design and project needs.

You can choose from mechanical, pneumatic, or even "no touch" actuation for a new level of hygiene and convenience at the wave of a hand.

All of them complement our bathroom ranges with superb aesthetics, technology, efficiency and performance. Behind the wall, they connect to our high-quality, reliable ProSys™ installation systems that give peace of mind for a wide range of applications and functions.



Flush plate: Symfo™ NT in black  
Wall-hung bowl: AquaBlade®; Strada II  
Vessel: Strada II 60cm  
Furniture: Adapto console 85cm in dark wood  
Vessel mixer: Edge

# Our tech, your touch



How do you give your bathroom design the perfect finishing touch?

Our products have innovative technologies that deliver perfect performance at the touch of a button.

Flush plate: Septa Pro™ E2 in chrome





Wall-hung bowl: Tesi  
Flush plate: Oless™ M2/P2 in matt chrome

**‘How do you give  
your bathroom design the  
perfect finishing touch?’**

## Our tech, your touch

# SmartFlush

Ideal Standard's SmartFlush is a self-contained refillable system, placed inside the cistern, where a disinfectant is stored. On each flush, an exact dose of disinfectant is dispensed directly into the toilet, without any effort from the user.

SmartFlush creates a fresh atmosphere and provides an immediate feeling of comfort and cleanliness.

In contrast to traditional disinfectant tablets, which are always in contact with water and might damage the cistern and its components, SmartFlush keeps the sanitising liquid in a separate container.

- Hygiene and cleanliness with every flush.
- Compatible with all chlorine-free disinfectants\*.
- Storage capacity of 450ml, sufficient for approximately 200 flushes.
- Controlled dosage: 2ml per flush.
- Fast and easy to refill – Simply push the flush plate to the side, pull out the nozzle and refill the container, then close the flush plate to enjoy weeks of freshness.
- Compatible with selected models in our range of OLEAS™ flush plates (mechanical actuation only).

\* The use of chlorine-free liquid detergents with a viscosity between 150 and 300 cp (at 20°C) is recommended.



Flush plate: Oleas™ M1 in chrome



Wall-hung bowl AquaBlade®: Connect Air



## Our tech, your touch SmartForce



Fit the system that generates its own energy to power an electronic control plate. This technology harnesses the power of the flushing water.\* It does not require a connection to the electrical grid or the replacement of batteries.

The system is available for our no-touch dual flush control plates Symfo™ and Altes™, which only require the approach of a hand to activate the flush. SmartForce is ideal for bathrooms that are regularly used. But even in case of reduced usage the battery can be easily recharged through the charger\*\* provided. The system is also a great choice for renovation projects when customers want to save time and money on electrical work as well as plumbing.

\* The presence of a high percentage of limescale in the water may cause obstructions in the hydroelectric generator, leading to malfunction.

\*\* At zero flushes per day the battery only needs to be recharged every five months.



Wall-hung bowl Aquablade®: Strada II  
Flush plate: Symfo™ NT1 in black glass  
Vessel: Ipalys® 55cm  
Furniture: Adapto console 120cm in light wood  
Vessel mixer: Edge



Wall-hung bowl AquaBlade®: Strada II  
Flush plate: Septa Pro™ E2 in polished chrome

Our tech, your touch

## No-touch technology



### **No-touch technology**

With no need to actually touch the plate to activate the flush, hygiene and convenience are brought to a new level. This is especially useful in environments where hygiene is an important factor, such as office or commercial washrooms with medium to high traffic.

### **Capacitive sensor technology**

Capacitive sensors in our ceramic and glass flush plates detect hand movement at approximately 20mm.

Choose between a half flush or a complete flush by simply moving your hand towards the corresponding symbol.

### **Infrared sensor technology**

The option of controlling the flush with an infrared sensor is perfect for commercial washrooms and public spaces and is available for WCs and urinals.

### **Vandal-resistant**

Another key option for commercial washrooms and public spaces is our vandal-resistant system, which makes it difficult for the flush plate to be opened for malicious purposes, and reduces maintenance and repair costs.



Urinal: Sphero™ Midi  
Flush plate: Septa Pro™ U2 in chrome

Flush plates

## Bathroom design taken to another level

All you have to decide is what functionality you need from your flush plate, and how you want it to fit with your bathroom design.

The perfect solution for all your design demands is in our range. From the right material, to the finish, to the shape of the plate and your choice of different flushes, we are completely confident you will find it here, whatever actuation method you require.





Flush plates

# Altes™ and Symfo™

Ideal Standard's new Altes™ and Symfo™ ranges follow the idea of creating unobtrusive, visually-appealing objects that provide lasting pleasure by playing their part in the customs of everyday life.

Along with aesthetics, functionality and the needs of the end user have also been key considerations in the design process. Both ranges feature the latest no-touch technology with capacitive sensors that can detect movement at around 20mm, which means that the user just hovers their hand over the half or full flush to trigger the action – making the flush plates both easy to use and ultra-hygienic.



Flush plate: Symfo™ NT1 in white glass  
Floor-standing bowl: Connect Air  
Fitting: Connect Air  
Vanity: Connect Air 54cm  
Furniture: Connect Air basin unit 50cm

The Altes™ range is made from a beautiful ceramic, giving the plates a unique and elegant 'silky' finish. Available in either black or white, it blends seamlessly into any environment.

Altes™ flush plates work particularly well with the soft geometric design and gentle minimalism of our Strada II ceramic range.

Symfo™ is a tempered glass plate, with a simple borderless design. Its reflective appearance gives a contemporary look and feel to bathrooms. Symfo™ flush plates are the perfect complement to the lighter design and thin curved rims of our Connect Air ceramic range.

R: Wall-hung bowl AquaBlade®; Connect Air  
L: Wall-hung bowl AquaBlade®; Strada II



**'Their aim is to create...  
objects that provide  
lasting pleasure'**

# Flush plates

## Altes™ NT1

Altes™ NT1: 234mm x 158mm, white finish

---

### Dimensions

- W: 234mm x H: 158mm

### Features

- Water-saving dual flush
- No-touch activation through capacitive sensors
- One piece ceramic material
- Hygienic and easy to clean
- Available in two different finishes



---

### Finishes



White



Black



Ideal Standard

# Flush plates

## Symfo™ NT1

Symfo™ NT1: 220mm x 150mm, black finish

---

### Dimensions

- W: 220mm x H: 150mm

### Features

- Water-saving dual flush
- No-touch activation through capacitive sensors with LED signs (multiple colours available)
- One piece tempered glass
- Hygienic and easy to clean
- Available in two different finishes



---

### Finishes

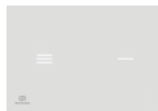

White

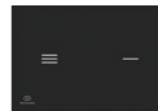

Black

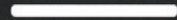

Flush plates  
**Oleas™**

Available from September 2019, the new Oleas™ collection has been developed as part of Ideal Standard's long-standing and successful partnership with Studio Levien. This collection features four minimalistic, highly functional models, which perfectly match the design of other bathroom elements, particularly the WC bowl and the basin, regardless of style.

Studio**Levien**





Robin Levien, founder of Studio Levien commented: "Sometimes design has to stand out, sometimes it has to fit in, the new flush plates are an example of design that fits in. We have round and square buttons on the flush plates to complement a new bathroom style that is emerging, which is a combination of round and square – you might describe it as soft square, a softer, slightly organic style."

Flush plates are not only about looks though, they are a 'touch point' in the bathroom and have to feel good too. Great care has gone into the movement – the resistance and the 'spring-back' of the buttons. The new Oleas™ flush plates look good, feel good, work well, and 'fit in'. Sounds easy, but actually takes some doing."

Oleas™ flush plates fit very well with the clean geometric lines and soft rounded forms of our Tesi ceramics range.

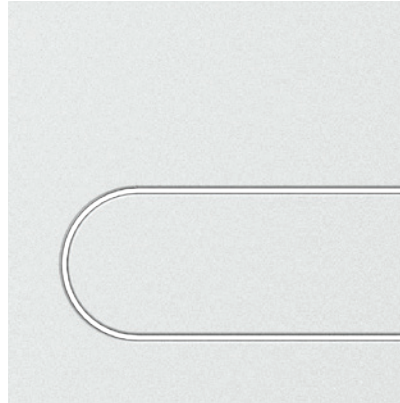

R : Wall-hung bowl AquaBlade® - Tesi  
L : Flush plate detail: Oleas™ M4, matt chrome finish

**'The new flush plates  
are an example of  
design that fits in'**

ROBIN LEVIEN

Flush plates

# Oleas™ M1/P1

Oleas™ M1/P1: 234mm x 154mm, matt chrome finish

## Dimensions

- W: 234mm x H: 154mm

## Features

- Round design
- Water-saving dual flush
- Mechanical or pneumatic actuation
- Actuation force < 20N
- Compatible with SmartFlush system (mechanical actuation and only selected colours)
- Available in four different finishes



## Finishes



White



Black



Chrome



Matt chrome

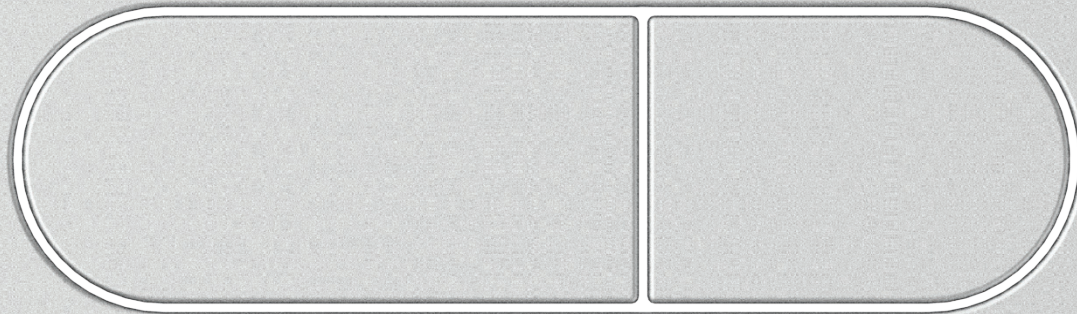

Ideal Standard

Flush plates

# Oleas™ M2/P2

Oleas™ M2/P2: 234mm x 154mm, black finish

## Dimensions

- W: 234mm x H: 154mm

## Features

- Square design
- Water-saving dual flush
- Mechanical or pneumatic actuation
- Actuation force < 20N
- Compatible with SmartFlush system (mechanical actuation and only selected colours)
- Available in four different finishes



## Finishes



White



Black



Chrome



Matt chrome

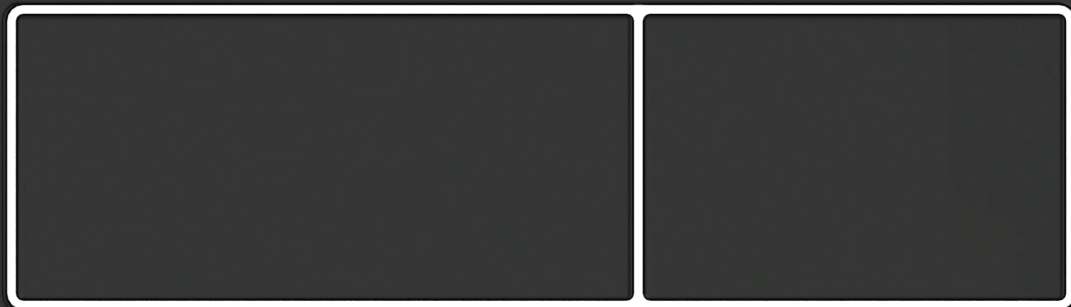

Flush plates

# Oleas™ M3/P3

Oleas™ M3/P3: 241mm x 165mm, white finish

## Dimensions

- W: 241mm x H: 165mm

## Features

- Soft-square design
- Water-saving dual flush
- Mechanical or pneumatic actuation
- Actuation force < 20N
- Available in four different finishes

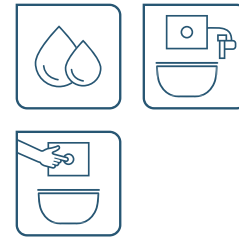

## Finishes



White



Black



Chrome



Matt chrome



Ideal Standard

# Flush plates

## Oleas™ M4

Oleas™ M4: 234mm x 154mm, chrome finish

---

### Dimensions

- W: 234mm x H: 154mm

### Features

- Round design
- Single flush
- Mechanical actuation
- Actuation force < 20N
- Available in three different finishes



---

### Finishes

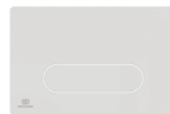

White



Chrome



Matt chrome



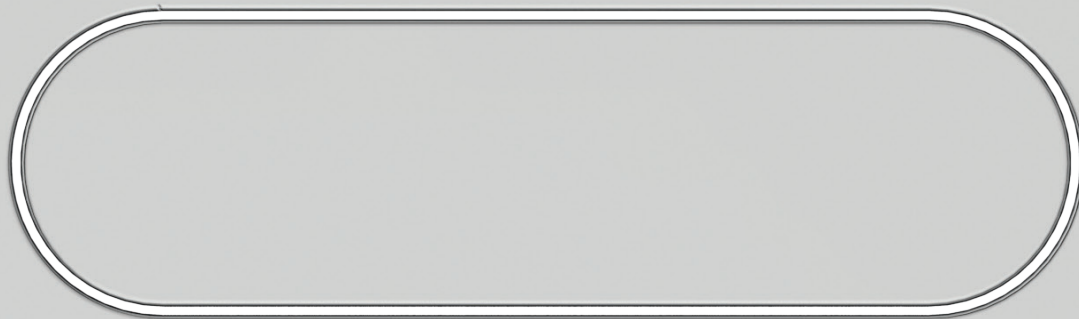

Ideal Standard

Flush plates  
**Solea™**



Flush plate: Solea™ P2, matt chrome finish  
Wall-hung bowl AquaBlade®: Connect Air

Solea™ flush plates are classic shapes that complement other bathroom fixtures and easily blend into any bathroom design. The range features products for mechanical and pneumatic flush actuation and comes in a variety of colours and finishes including black soft-touch.

Solea™ M1 is a simple all-rounder that brings a timeless finish to your bathroom. Our M2 model combines straight and curved lines that complement a wide range of ceramics while the P1 model features organic round shapes in a soft minimalist design. The strikingly linear shape of Solea™ P2 adds a clean and defined look to your bathroom.

All Solea™ models feature dual flush so users choose how much water to use when flushing the toilet.



R: Flush plate detail: Solea™ M1, chrome finish  
L: Flush plate detail: Solea™ P1, matt chrome finish

**'Solea™ flush plates  
blend into any  
bathroom design'**

# Flush plates

## Solea™ M1

Solea™ M1: 245mm x 160mm, chrome finish

### Dimensions

- W: 245mm x H: 160mm

### Features

- Water-saving dual flush
- Mechanical actuation
- Actuation force < 20N
- Available in two different finishes



### Finishes



White



Chrome

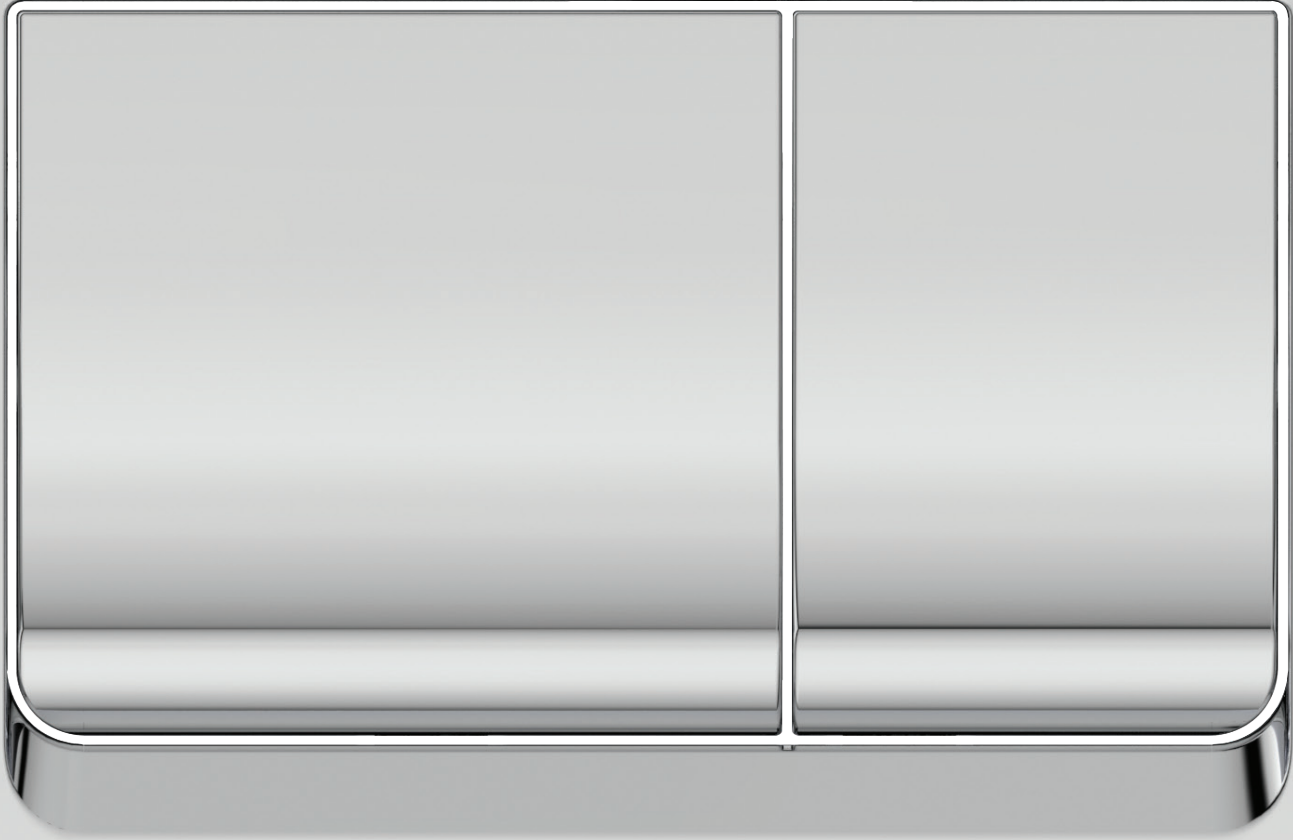

Ideal Standard

# Flush plates

## Solea™ M2

Solea™ M2: 245mm x 165mm, white finish

---

### Dimensions

- W: 245mm x H: 165mm

### Features

- Water-saving dual flush
- Mechanical actuation
- Actuation force < 20N
- Available in two different finishes



---

### Finishes



White



Chrome



Ideal Standard

# Flush plates

## Solea™ P1

### Dimensions

- W: 215mm x H: 145mm

### Features

- Water-saving dual flush
- Pneumatic actuation
- Actuation force < 20N
- Available in three different finishes



### Finishes



White



Chrome



Matt chrome



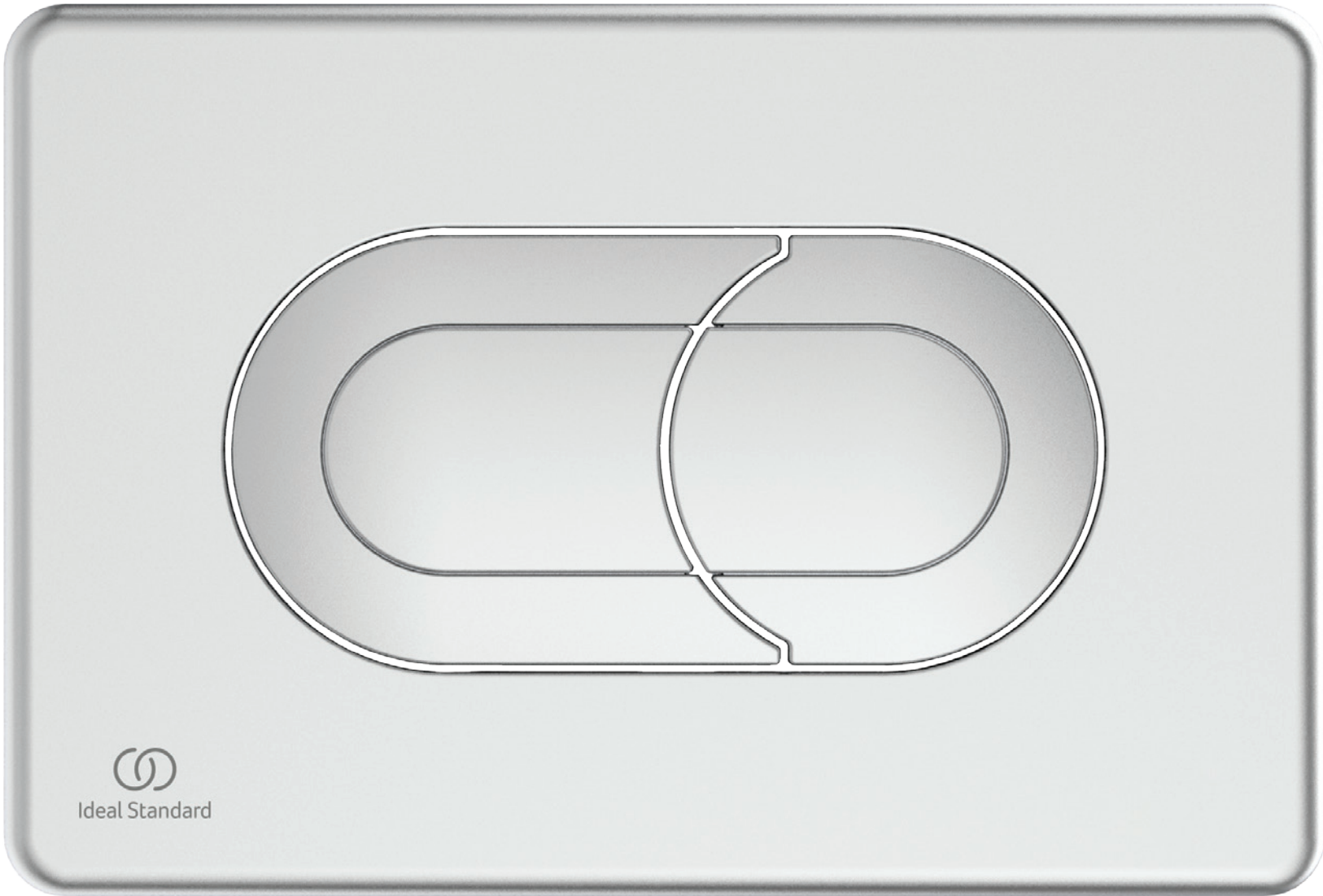

# Flush plates

## Solea™ P2

Solea™ P2: 230mm x 146mm, soft-touch black finish

### Dimensions

- W: 230mm x H: 146mm

### Features

- Water-saving dual flush
- Pneumatic actuation
- Actuation force < 20N
- Available in four different finishes



### Finishes



White



Black soft-touch

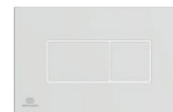

Chrome



Matt chrome



Flush plates

**Septa Pro™**

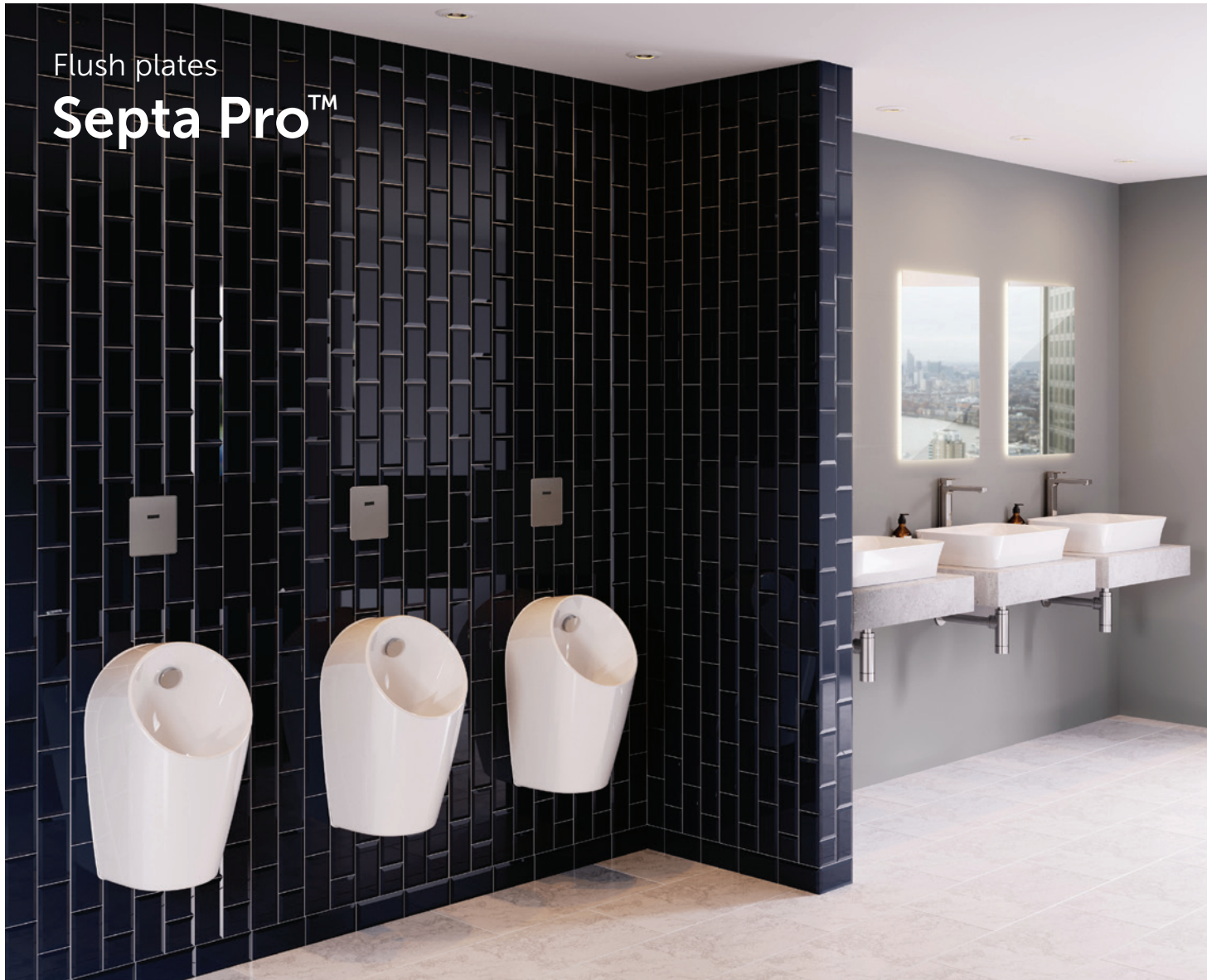

Urinals: Sphero™ Midi  
Urinal flush plate: Septa Pro™ UI in Brushed stainless steel

Our range of Septa Pro™ flush plates are known for their versatility and durability. They come in a variety of shapes, sizes and finishes which makes them the perfect choice for any situation.

Vandal-resistant and made with robust materials, they are particularly suitable for commercial, public and semi-public washrooms. High-tech features such as infrared actuation sensors also help make them more hygienic as there is no need to touch the flush plate.

Additionally, the range includes models that can be installed away from the cistern for remote activation and easier access.

Our matching urinal flush plates help completing your bathroom vision.



**'Septa Pro™ ...  
the perfect choice  
for any situation'**

R : Flush plate: Septa Pro™ P1, chrome finish  
Wall-hung bowl Aquablade®: Connect Air  
L: Flush plate detail: Septa Pro™ P1, chrome finish

Flush plates

# Septa Pro™ E1

Septa Pro™ E1: 243mm x 163mm, chrome finish

## Dimensions

- W: 243mm x H: 163mm

## Features

- Water-saving dual flush
- Infrared sensor actuation with mechanical override
- Actuation force < 20N
- Vandal-resistant
- Zamac material
- Matching urinal control plate available (see page 66)



## Finishes



Chrome



  
Ideal Standard

# Flush plates

## Septa Pro™ E2

Septa Pro™ E2: 243mm x 163mm, chrome finish

### Dimensions

- W: 243mm x H: 163mm

### Features

- Water-saving dual flush
- Infrared sensor actuation
- Vandal-resistant
- Zamac material
- Matching urinal control plate available (see page 66)



### Finishes

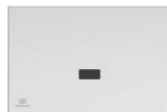

Chrome



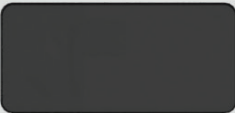

Flush plates

# Septa Pro™ M1

Septa Pro™ M1: 243mm x 163mm, chrome finish

---

## Dimensions

- W: 243mm x H: 163mm

## Features

- Water-saving dual flush
- Mechanical actuation
- Actuation force < 20N
- Vandal-resistant
- Zamac material

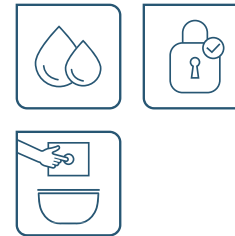

---

## Finishes



Chrome



Ideal Standard

Flush plates

# Septa Pro™ M2

Septa Pro™ M2: 243mm x 163mm, chrome finish

## Dimensions

- W: 243mm x H: 163mm

## Features

- Single flush
- Mechanical actuation
- Actuation force < 20N
- Vandal-resistant
- Zamac material

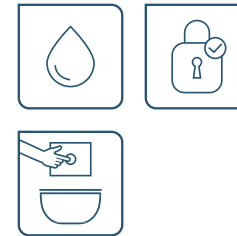

## Finishes



Chrome



Ideal Standard

Flush plates

# Septa Pro™ P1

Septa Pro™ P1: 215mm x 145mm, chrome finish

## Dimensions

- W: 215mm x H: 145mm

## Features

- Water-saving dual flush
- Pneumatic actuation
- Actuation force < 20N
- Vandal-resistant
- Matching urinal control plate available (see page 68)

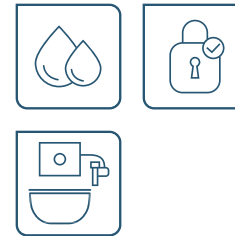

## Finishes



Chrome

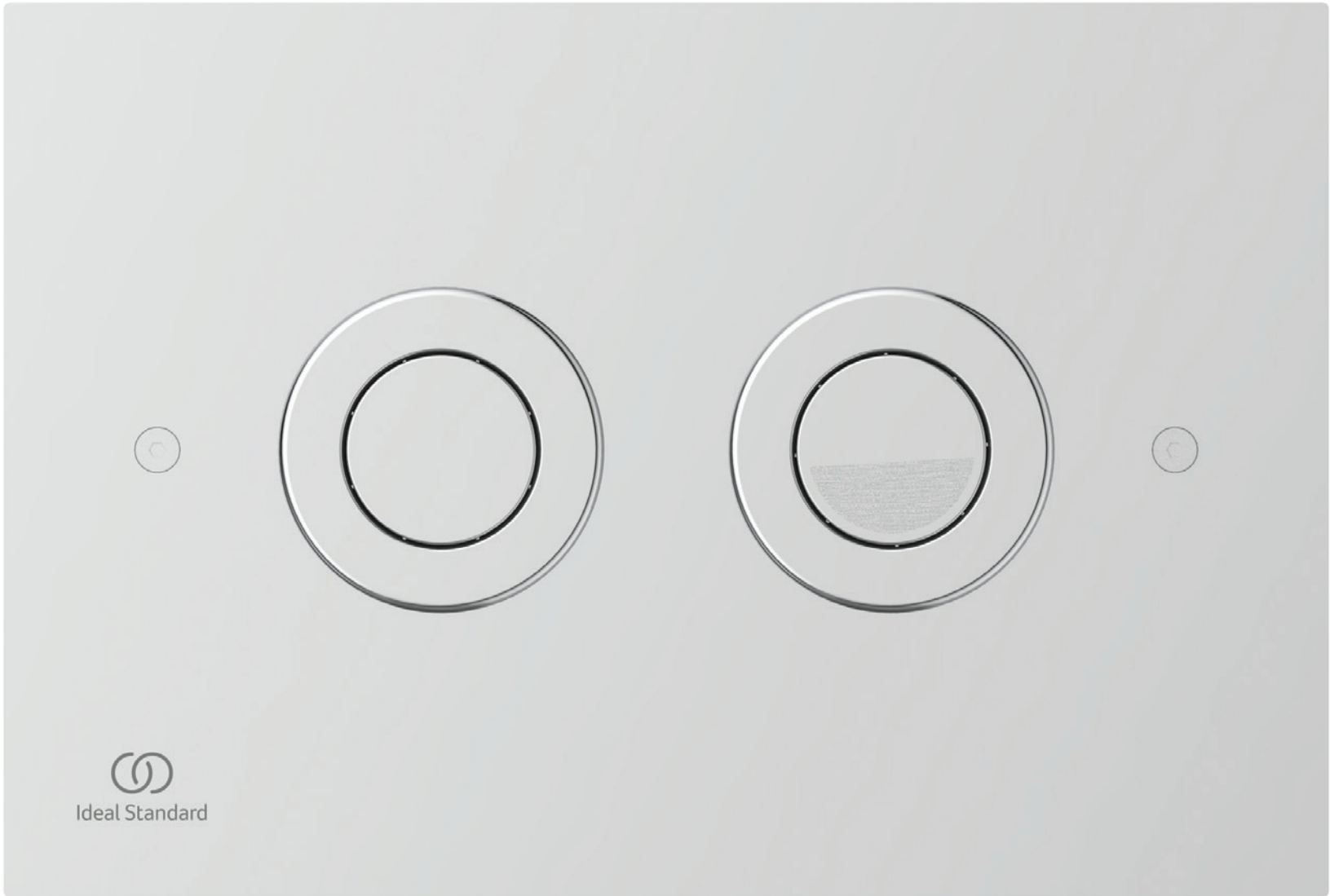

# Flush plates

## Septa Pro™ P2

Possibility for installation away from the cistern for remote activation and easier access.

### Dimensions

- W: 155mm x H: 85mm

### Features

- Water-saving dual flush
- Pneumatic actuation
- Actuation force < 20N
- Vandal-resistant
- Matching urinal control plate available (see page 68)



### Finishes



Chrome



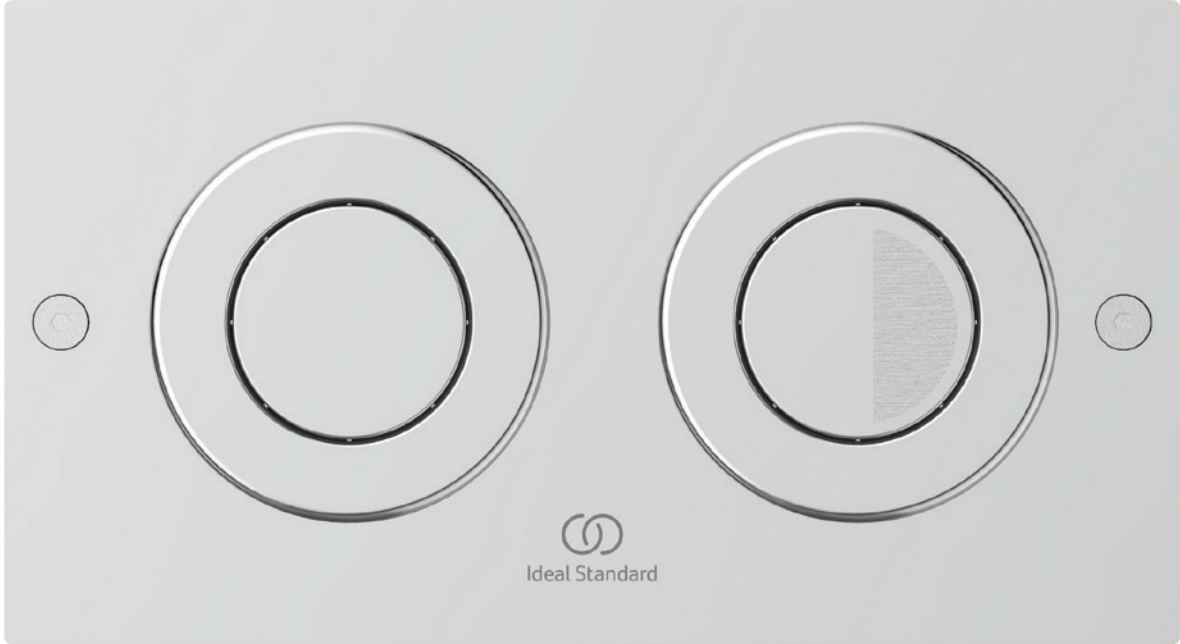

# Flush plates

## Septa Pro™ P3

Possibility for installation away from the cistern for remote activation and easier access.

### Dimensions

- W: 95mm x H: 95mm

### Features

- Single flush
- Pneumatic actuation
- Actuation force < 20N
- Vandal-resistant
- Matching urinal control plate available (see page 68)

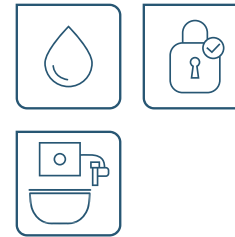

### Finishes



Chrome



## Flush plates

# Septa Pro™ P4

For installation away from the cistern.  
Not meant to be used in the opening of an in-wall cistern.

**Septa Pro™ P4 is compliant with Safety Regulations against Fire and Panic Hazards in Public Buildings (ERP) – Article Co 31.**

### Dimensions

- W: 118mm x H: 118mm

### Features

- Water-saving dual flush
- Pneumatic actuation
- Actuation force < 20N
- Vandal-resistant
- Available in two different finishes
- Adjustable buttons that can be set at 3 depths: 32mm, 18mm, and 0mm

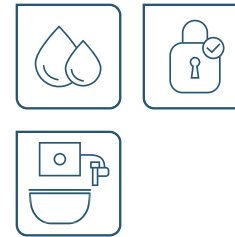

### Finishes



White



Chrome



Flush plates

# Septa Pro™ Floor

For installation on the floor.  
Not meant to be used in the opening of an in-wall cistern.

---

## Dimensions

- W: 120mm x H: 120mm

## Features

- Single flush
- Pneumatic actuation foot control
- Anti-sliding push button
- Vandal-resistant
- Stainless steel material

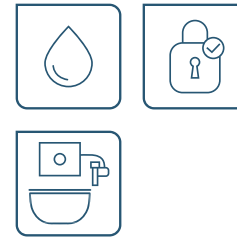

---

## Finishes



Stainless  
Steel



# Flush plates

## Septa™ XS P1/P2

For installation away from the cistern.  
Not meant to be used in the opening of an in-wall cistern.

### Dimensions

- XS P1: 48mmØ
- XS P2: 105mmØ

### Features

- Single flush
- Pneumatic actuation
- Available in two different designs and finishes
- P1 is a finger push button while P2 is a palm push model



### Finishes



XS P1  
Chrome



XS P2  
White





# Flush plates | Urinal

## Septa Pro™ U1

### Dimensions

- W: 119mm x H: 139mm

### Features

- Dynamic sensor adjusts to optimum range
- 24 or 48 hygienic duty flush mode
- Flush time and sensor sensitivity can be adjusted manually
- Vandal-resistant
- Matching WC control, plates available (see pages 46-49)



### Finishes



Stainless steel

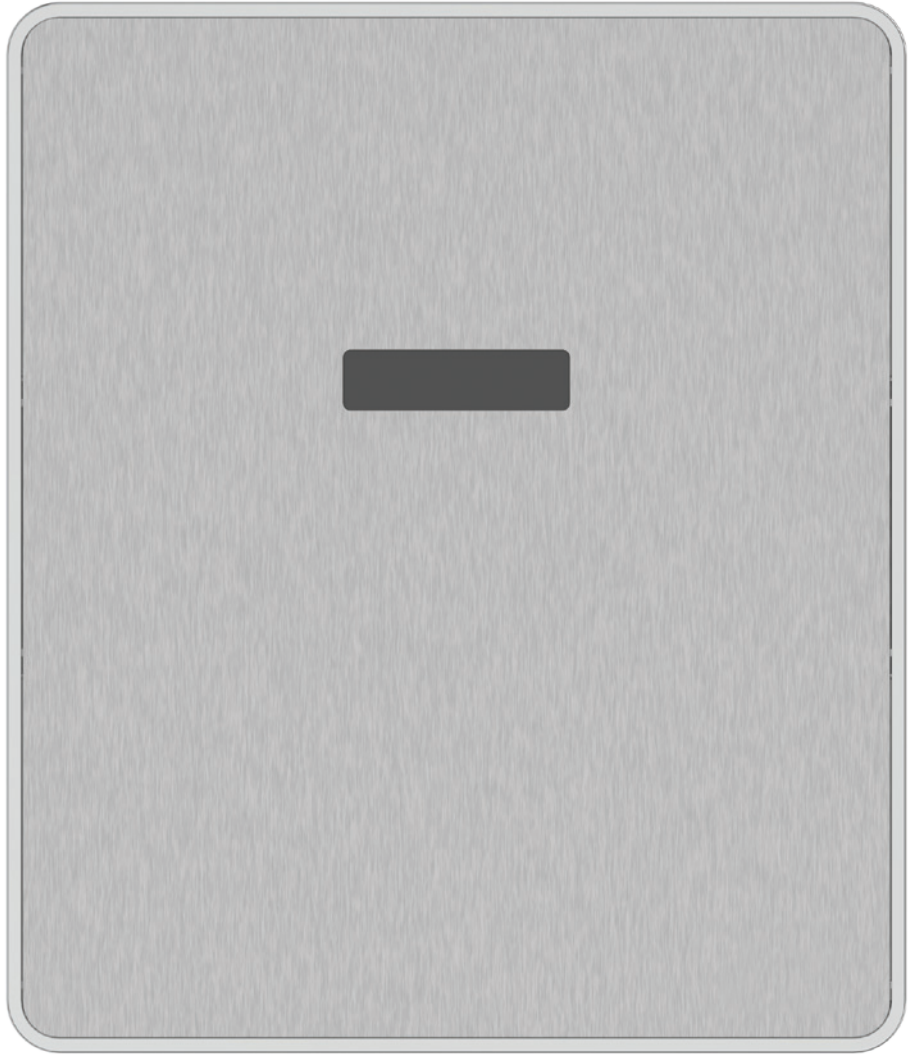

# Flush plates | Urinal

## Septa Pro™ U2

Septa Pro™ U2: 128mm x 175mm, chrome finish

### Dimensions

- W: 128mm x H: 175mm

### Features

- Single flush
- Mechanically actuated flush valve
- Adjustable flush time and flow
- Vandal-resistant
- Zamac material
- Matching WC control plate available (see page 54-59)

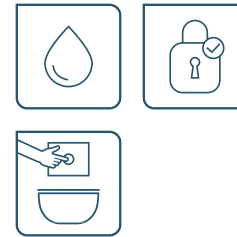

### Finishes



Chrome



# Flush plates | Urinal

## Septa Pro™ U3

Septa Pro™ U3: 124mm x 150mm, white finish

### Dimensions

- W: 124mm x H: 150mm

### Features

- Single flush
- Mechanically actuated
- Vandal-resistant
- Available in three finishes

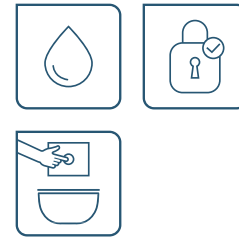

### Finishes



White



Chrome



Matt  
chrome







## ProSys™ Installation Systems

# Confidence from the inside out

Wall-hung bowl AquaBlade®: Strada II  
Basin: Strada II 60cm  
Fitting: Edge  
WC frame: ProSys™ 120  
Basin frame: ProSys™ deck taps

ProSys™ is the concealed solution that delivers your bathroom vision on every level. Our comprehensive and versatile range of pre-wall solutions for WCs and urinals is the perfect match for Ideal Standard's flush plates and ceramics.

Our cisterns are available in three different depths to suit different wall thicknesses: ProSys™ 120, ProSys™ 80 and ProSys™ 150. They are delivered as a variety of installation systems for drywall and solid wall construction. Our universal urinal frame guarantees an easy installation of the concealed flush valve of our urinal flush plates.

All our solutions are easy and quick to install which saves time and money.



The inside of the concealed cistern can simply be accessed via the flush plate and no specific tools are necessary to maintain or remove the components.

All our cisterns are equipped with the Ideal Standard SmartValve – a special delayed fill inlet valve that can save up to 63 litres of water a week. Water waste is avoided during flushing by only allowing water into the cistern after the flush valve is closed.

The ProSys™ range of installation systems delivers innovative features that save water, energy and improve hygiene making it the perfect choice for any project.

## 10 year warranty for our frames, 5 years for our cisterns and 25 year spare part availability

ProSys™

# WC and urinal solutions



## ProSys™ 120

- Available as concealed cistern, light frame, frame, freestanding and height-adjustable frame.
- Easy maintenance through the service tunnel directly behind the flush plate or inspection plate if flush plate was positioned adjacent to the WC.
- Front actuation.



## ProSys™ 80

- Available as concealed cistern, light frame and frame.
- Ideal for small spaces.
- Ideal for thin brickwork.
- Front actuation.



## ProSys™ 150

- Available as concealed cistern, frame and freestanding frame.
- Ideal for lower wall application.
- Front and top actuation.



## ProSys™ Universal Urinal Frame

- Ideal for Ideal Standard's push and proximity flush plates.
- Easy and quick installation with easy fixations wall brackets.

ProSys™

# Benefits at a glance

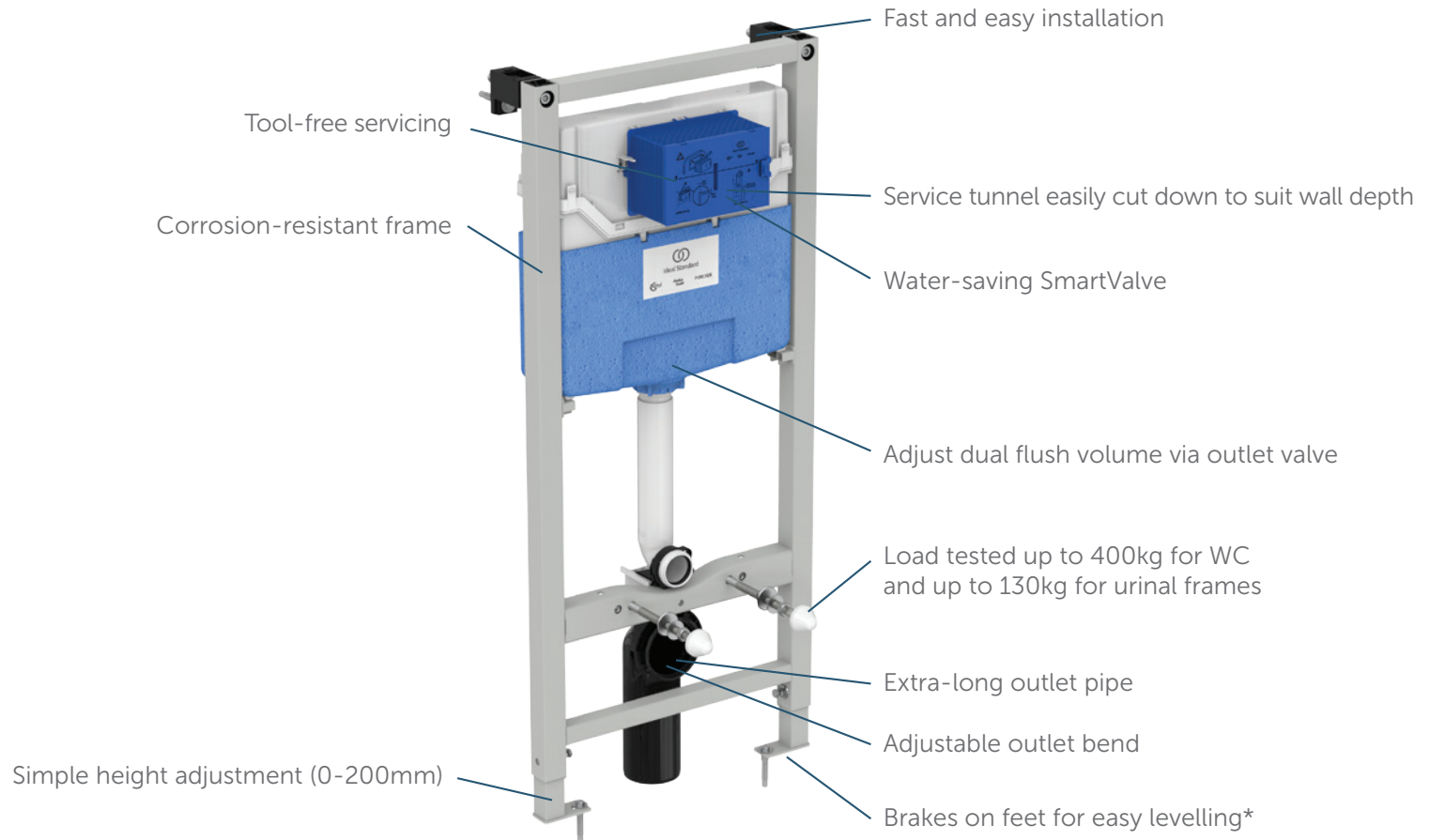

\* Available for ProSys™ 120 and ProSys™ 150 frames

# Proven reliability

We have sold over 5 million cisterns in 10 different countries in the last 50 years, which testify to the high quality of our products. It's this expertise, especially in associated technical components such as flush mechanisms, that we bring to our flush plates and pre-wall solutions.

All of our products are thoroughly lab-tested during development, and undergo stress, endurance, noise and hydraulic testing. We test our products against the most stringent tests, including NF and WRAS, so that our customers are aware that our quality meets the highest standards.

---

## European Construction Products Regulation

In accordance to the Construction Products regulation CPR305/2013 all cisterns sold by Ideal Standard are CE marked and produced and tested according to the harmonised product standard EN 14055.

## NF Certification

Our products are tested for NF certification. This is a quality and safety benchmark recognised in Europe and means they have been successfully load tested to the necessary weights i.e. 400 kg for the WC frame and also salt spray tested for 200 hours to ensure they are corrosion resistance to last many years. In addition our cisterns have been tested for sound protection and certified to class 1 which is the highest standard achievable.

---

## WRAS

Ideal Standard products are tested according to WRAS requirements for the design, installation, operation and maintenance of plumbing systems, water fittings and appliances that use water, to prevent misuse, waste and contamination of drinking water.

## Fire Safety

All material components used by Ideal Standard to produce our cisterns are rated fire resistance class EI 120 conforming to EN 13502-2:2016. This fire resistance class covers all requirements from a single family house to high-rise buildings.

## Flush Performance

We have tested our WC bowls with our frames and cisterns and can therefore reassure customers that matching the ProSys™ pre-wall range with our WCs will ensure optimum flush performance.

# Compatibility with cisterns and conversion kits

M: mechanical actuation  
 P: pneumatic actuation  
 M F: mechanical front actuation  
 M T: mechanical top actuation  
 N/C: not compatible  
 1: Denotes SmartForce

	MODEL	INSTALLATION ProSys™ 120 M	INSTALLATION ProSys™ 120 P	INSTALLATION ProSys™ 80 M	INSTALLATION ProSys™ 150 M F	INSTALLATION ProSys™ 150 M T	
Mechanical	Oleas™ M1	•	N/C	•	•	+ R017667	
	Oleas™ M2	•	N/C	•	•	+ R017667	
	Oleas™ M3	•	N/C	•	•	+ R017667	
	Oleas™ M4	•	N/C	•	•	+ R017667	
	Solea™ M1	•	N/C	•	•	•	
	Solea™ M2	•	N/C	•	•	•	
	Septa Pro™ M1	•	N/C	•	•	•	
	Septa Pro™ M2	•	N/C	•	•	•	
Pneumatic	Oleas™ P1	+ R009867	•	+ R014967	+ R009267	+ R009267	
	Oleas™ P2	+ R009867	•	+ R014967	+ R009267	+ R009267	
	Oleas™ P3	+ R009867	•	+ R014967	+ R009267	+ R009267	
	Solea™ P1	+ R009867	•	+ R014967	+ R009267	+ R009267	
	Solea™ P2	+ R009867	•	+ R014967	+ R009267	+ R009267	
	Septa Pro™ P1	+ R009867	•	+ R014967	+ R009267	+ R009267	
	Septa Pro™ P2	+ R009867	•	+ R014967	+ R009267	+ R009267	
	Septa Pro™ P3	+ R009867	•	+ R014967	+ R009267	+ R009267	
	Septa Pro™ P4	+ R009867	•	+ R014967	+ R009267	+ R009267	
	Septa Pro™ Floor	+ R009867	•	+ R014967	+ R009267	+ R009267	
	Septa™ XS P1	+ R009867	•	+ R014967	+ R009267	+ R009267	
	Septa™ XS P2	+ R009867	•	+ R014967	+ R009267	+ R009267	
	Electronic	Symfo™ NT1	+ R015867/R015767 <sup>1</sup>	+ R015867	+ R015067/R019167 <sup>1</sup>	N/C	N/C
		Altes™ NT1	+ R015867/R015767 <sup>1</sup>	+ R015867	+ R015067/R019167 <sup>1</sup>	N/C	N/C
Septa Pro™ E1		+ R009967	+ R009967	+ R015167	N/C	N/C	
Septa Pro™ E2		+ R009967	+ R009967	+ R015167	N/C	N/C	

# Minimum wall thickness (mm)

	MODEL	INSTALLATION ProSys™ 120 M	INSTALLATION ProSys™ 120 P	INSTALLATION ProSys™ 80 M	INSTALLATION ProSys™ 150 M F	INSTALLATION ProSys™ 150 M T
Mechanical	Oleas™ M1	15	15	0	0	0
	Oleas™ M2	15	15	0	0	0
	Oleas™ M3	15	15	0	0	0
	Oleas™ M4	15	15	0	0	0
	Solea™ M1	10	10	0	0	0
	Solea™ M2	10	10	0	0	0
	Septa Pro™ M1	10	10	0	0	0
	Septa Pro™ M2	10	10	0	0	0
Pneumatic	Oleas™ P1	30	30	30	0	10
	Oleas™ P2	30	30	30	0	10
	Oleas™ P3	30	30	30	0	10
	Solea™ P1	20	20	25	0	20
	Solea™ P2	25	25	25	0	20
	Septa Pro™ P1	10	10	0	0	0
	Septa Pro™ P2*	N/A	N/A	N/A	N/A	N/A
	Septa Pro™ P3*	N/A	N/A	N/A	N/A	N/A
	Septa Pro™ P4*	N/A	N/A	N/A	N/A	N/A
	Septa™ XS P1*	N/A	N/A	N/A	N/A	N/A
	Septa™ XS P2*	N/A	N/A	N/A	N/A	N/A
	Electronic	Septa Pro™ E1	10	10	0	N/C
Septa Pro™ E2		10	10	0	N/C	N/C
Altes™ NT1		10	10	10	N/C	N/C
Symfo™ NT1		10	10	10	N/C	N/C

N/A: not applicable  
N/C: not compatible

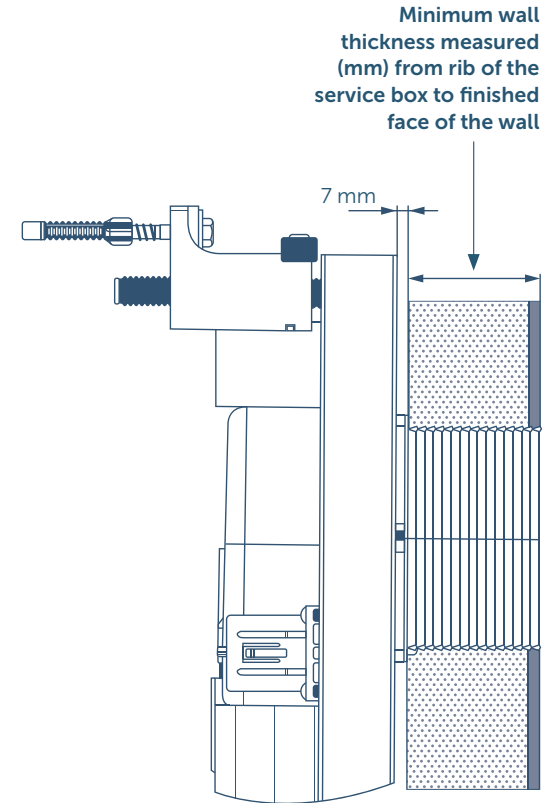

\*No minimum wall thickness required as flush plate is not installed in front of the cistern.  
An inspection plate is required to access the cistern.



Flush plate: Attes NT1, white finish  
Wall-hung bowl AguaBlade®: Connect Air  
Fitting: Connect Air  
Vanity: Connect Air 80cm  
Furniture: Connect Air basin unit 80cm

# Technical information



## Altes™ NT1

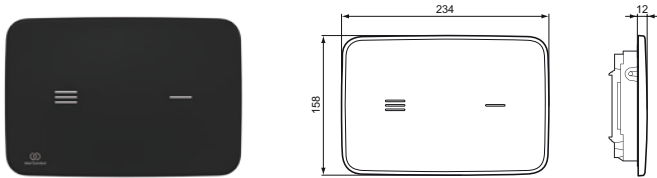

### Model

NT1 White  
NT1 Black

### Ref

R0130AC  
R0130A6

- One-piece ceramic material
- Dual flush
- No-touch activation through capacitive sensors
- Detection capacity – about 20mm
- Sensor sensitivity adjustment
- Duty flush and timing
- Waterproof connectors
- Anti-error electronic connections
- Operating temperature 0 – 70°C
- Degree of sensor protection: IP67
- Electronic connectors anti-error and waterproof: IP66
- Hygienic and easy to clean



## Symfo™ NT1

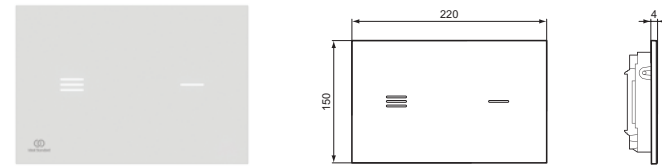

### Model

NT1 White  
NT1 Black

### Ref

R0129SA  
R0129RX

- One-piece tempered glass
- Dual flush
- No-touch activation through capacitive sensors with LED signs (sensor lighting adjustment; multiple LED back light colours: blue, red, yellow, white, green, violet, orange and purple)
- Detection capacity – about 20mm
- Sensor sensitivity adjustment
- Duty flush and timing
- Gull-Wing opening system which prevents damages to the control plate in actions of installation and maintenance
- Waterproof connectors
- Anti-error electronic connections
- Hygienic and easy to clean





## Oleas™ M1

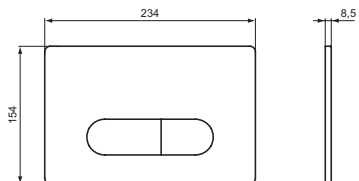

Model
M1 White
M1 White SmartFlush
M1 Chrome
M1 Chrome SmartFlush
M1 Matt Chrome
M1 Matt Chrome SmartFlush
M1 Black

Ref
R0115AC
R0117AC
R0115AA
R0117AA
R0115JG
R0117JG
R0115A6

- Round design
- Dual flush
- Mechanical actuation
- Actuation force < 20N
- SmartFlush variants available



## Oleas™ M2

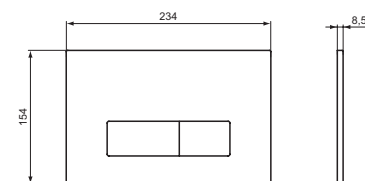

Model
M2 White
M2 White SmartFlush
M2 Chrome
M2 Chrome SmartFlush
M2 Matt Chrome
M2 Matt Chrome SmartFlush
M2 Black

Ref
R0121AC
R0122AC
R0121AA
R0122AA
R0121JG
R0122JG
R0121A6

- Square design
- Dual flush
- Mechanical actuation
- Actuation force < 20N
- SmartFlush variants available

# Technical information



## Oleas™ M3

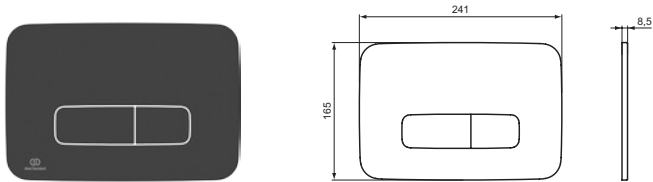

### Model

M3 White  
M3 Chrome  
M3 Matt Chrome  
M3 Black

### Ref

R0123AC  
R0123AA  
R0123JG  
R0123A6

- Soft-square design
- Dual flush
- Mechanical actuation
- Actuation force < 20N



## Oleas™ M4

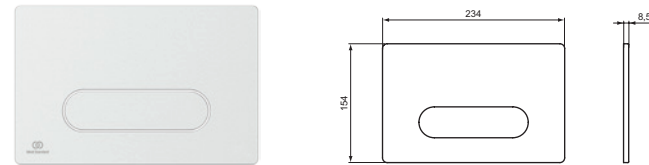

### Model

M4 White  
M4 Chrome  
M4 Matt Chrome

### Ref

R0126AC  
R0126AA  
R0126JG

- Round design
- Single flush
- Mechanical actuation
- Actuation force < 20N



## Oleas™ P1

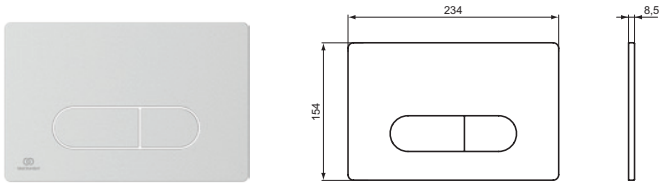

### Model

P1 White  
P1 Chrome  
P1 Matt Chrome

### Ref

R0116AC  
R0116AA  
R0116JG

- Round design
- Dual flush
- Pneumatic actuation
- Actuation force < 20N



## Oleas™ P2

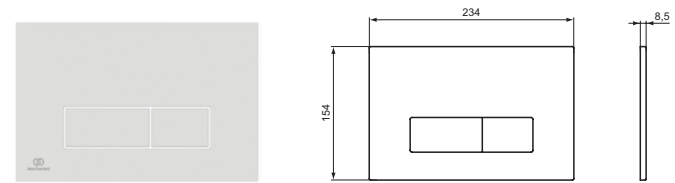

### Model

P2 White  
P2 Chrome  
P2 Matt Chrome

### Ref

R0119AC  
R0119AA  
R0119JG

- Square design
- Dual flush
- Pneumatic actuation
- Actuation force < 20N

# Technical information



## Oleas™ P3

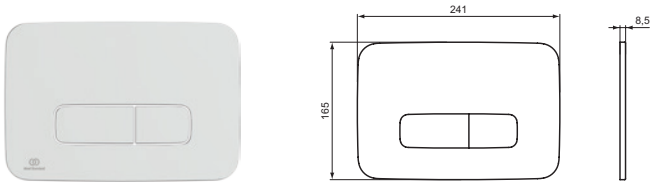

### Model

P3 White  
P3 Chrome  
P3 Matt Chrome

### Ref

R0124AC  
R0124AA  
R0124JG

- Soft-square design
- Dual flush
- Pneumatic actuation
- Actuation force < 20N



## Solea™ M1

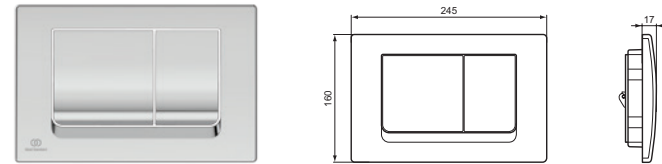

### Model

M1 White  
M1 Chrome

### Ref

R0108AC  
R0108AA

- ABS material
- Dual flush
- Mechanical actuation
- Actuation force < 20N



## Solea™ M2

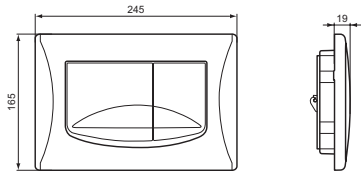

### Model

M2 White  
M2 Chrome

### Ref

R0109AC  
R0109AA

- ABS material
- Dual flush
- Mechanical actuation
- Actuation force < 20N



## Solea™ P1

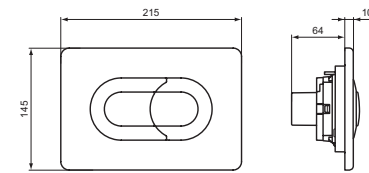

### Model

P1 White  
P1 Chrome  
P1 Matt Chrome

### Ref

R0133AC  
R0133AA  
R0133JG

- ABS material
- Dual flush
- Pneumatic actuation
- Actuation force < 20N

# Technical information



## Solea™ P2

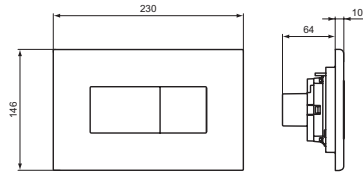
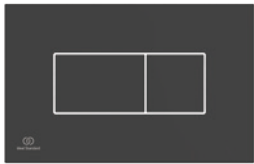

### Model

P2 White  
P2 Chrome  
P2 Matt Chrome  
P2 Black Soft-Touch

### Ref

R0110AC  
R0110AA  
R0110JG  
R0110A6

- ABS material
- Dual flush
- Pneumatic actuation
- Actuation force < 20N



## Septa Pro™ E1

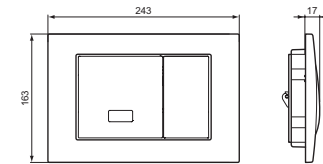

### Model

E1 Chrome

### Ref

R0131AA

- Zamac material
- Dual flush (< 60s half flush; > 60s full flush)
- Infrared actuation or mechanical actuation (in case of electricity failure)
- Actuation force < 20N
- Flushes are activated when the user moves away
- Automatic
- Pre-installed power supply connection required for transformer
- Transformer 230v/120 included
- Auto flush every 24 hours
- Vandal-resistant



## Septa Pro™ E2

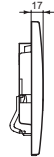
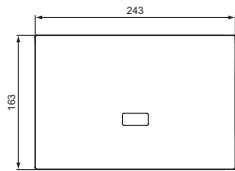
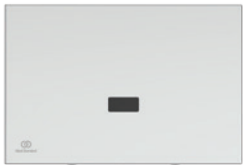

Model	Ref
E2 Chrome	R0132AA

- Zamac material
- Dual flush (< 60s half flush; > 60s full flush)
- Infrared actuation
- Flushes are activated when the user moves away
- Pre-installed power supply connection required for transformer
- Transformer 230v/120 included
- Vandal-resistant



## Septa Pro™ M1

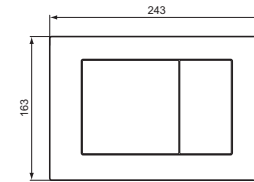

Model	Ref
M1 Chrome	R0127MY

- Zamac material
- Dual flush
- Mechanical actuation
- Actuation force < 20N
- Vandal-resistant

# Technical information



## Septa Pro™ M2

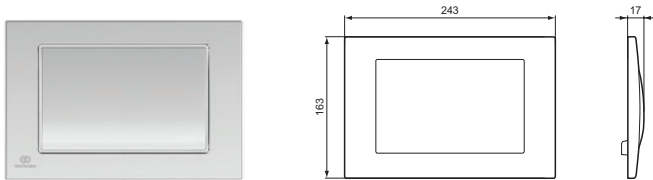

Model	Ref
M2 Chrome	R0128MY

- Zamac material
- Single flush
- Mechanical actuation
- Actuation force < 20N
- Vandal-resistant



## Septa Pro™ P1

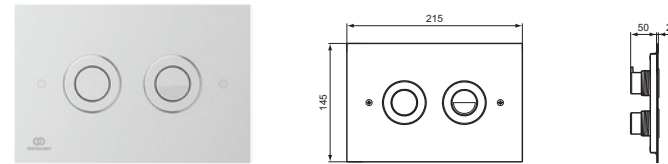

Model	Ref
P1 Chrome	R0188MY

- Polished chrome finish
- Dual flush
- Pneumatic actuation
- Actuation force < 20N
- Fixing material and pneumatic pipe not included
- Vandal-resistant





## Septa Pro™ P2



Model	Ref
P2 Chrome	R0134MY

- For remote installation
- Polished chrome finish
- Dual flush
- Pneumatic actuation
- Actuation force < 20N
- Supplied with fixing material, pneumatic pipe (2,5m) and protective pipe cover (3m)
- Vandal-resistant
- Septa Pro inspection plate (separate order) is required to access the cistern



## Septa Pro™ P3

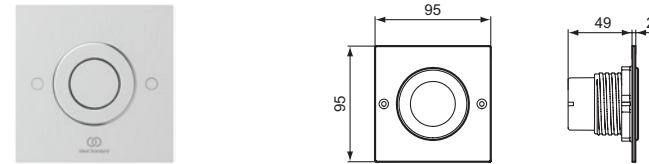

Model	Ref
P3 Chrome	R0135MY

- For remote installation
- Polished chrome finish
- Single flush
- Pneumatic actuation
- Actuation force < 20N
- Supplied with fixing material, pneumatic pipe (2,5m) and protective pipe cover (3m)
- Vandal-resistant
- Septa Pro inspection plate (separate order) is required to access the cistern

# Technical information



## Septa Pro™ P4

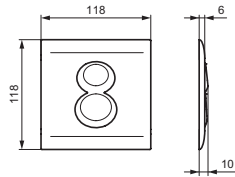

### Model

P4 White  
P4 Chrome

### Ref

R0136AC  
R0136AA

- For remote installation
- ABS material
- Dual flush
- Pneumatic actuation
- Actuation force < 20N
- Vandal-resistant
- **Compliant with Safety Regulations against Fire and Panic Hazards in Public Buildings (ERP) – Article Co 31.**
- Septa Pro™ inspection plate (separate order) is required to access the cistern

For remote installation order separately:

R019667 ProSys™ pneumatic pipe 3m x 2

R019767 ProSys™ corrugated pneumatic barrier pipe 1.8m



## Septa Pro™ Floor

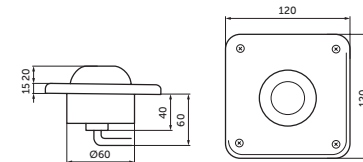

### Model

Stainless Steel

### Ref

R0138MY

- For remote installation
- Stainless steel material
- Single flush
- Pneumatic actuation foot control
- Anti-sliding push button
- Supplied with fixing material, pneumatic pipe (2,5m) and protective pipe cover (2,5m)
- Vandal-resistant
- Septa Pro™ inspection plate (separate order) is required to access the cistern



## Septa™ XS P1

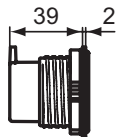
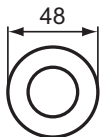

### Model

XS P1 Chrome

### Ref

P0109AA

- For remote installation
- ABS material
- Single flush
- Pneumatic actuation
- For light wall installation only
- Septa Pro™ inspection plate (separate order) is required to access the cistern

For remote installation order separately:  
R019667 ProSys™ pneumatic pipe 3m x 2  
R019767 ProSys™ corrugated pneumatic barrier pipe 1.8m



## Septa™ XS P2

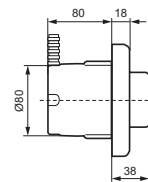
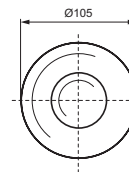

### Model

XS P1 White

### Ref

R0184AC

- For remote installation
- ABS material
- Single flush
- Pneumatic actuation
- Supplied with fixing material, pneumatic pipe (2,5m) and protective pipe cover (2,5m)
- Septa Pro™ inspection plate (separate order) is required to access the cistern

# Technical information



## Septa Pro™ U1

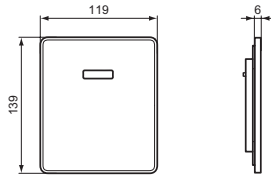

### Model

U1 Brushed stainless steel

### Ref

P0114AA

- Stainless steel material
- Double infrared sensor (with automatic setting feature)
- Dynamic sensor: constantly adjusts the optimum range
- Flush time and sensor sensitivity adjustable with touch
- Temporary off for cleaning and short on to trigger a cleaning flush via touch
- 24 or 48 hour auto flush for hygiene
- Vandal-resistant



## Septa Pro™ U2

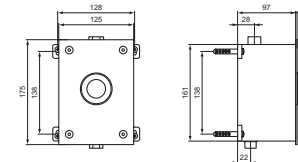

### Model

U2 Chrome

### Ref

P0115AA

- Zamac material
- Single flush
- Mechanically actuated flush valve
- Adjustable flush time and flow
- Vandal-resistant



## Septa Pro™ U3

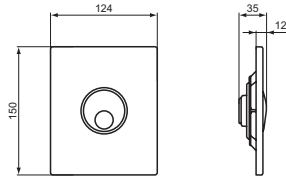

### Model

U3 White  
U3 Chrome  
U3 Matt Chrome

### Ref

R0139AC  
R0139AA  
R0139JG

- ABS material
- Single flush
- Mechanically actuated
- Available in three colours
- Flow pressure 0,8 - 5 bar
- Flush volume 0,3l/s
- Vandal-resistant



## Septa Pro™ Inspection Plate

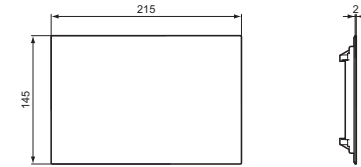

### Model

White  
Chrome  
Matt Chrome

### Ref

R0137AC  
R0137AA  
R0137JG

- Required when flush plate is fitted in remote position (not directly to cistern)
- Provides maintenance access to cistern
- ABS material for white model
- Stainless steel material for chrome and matt chrome models
- Compatible with all ProSys™ cisterns
- Vandal-resistant

# Technical information



## ProSys™ Pneumatic Conversion Kit 120



Model	Ref
Conversion Kit 120 P	R009867

- Conversion from mechanical to pneumatic actuation
- 2 x 350mm pneumatic pipes
- Outlet valve pneumatic anchors
- Pneumatic bellows
- Compatible with ProSys™ 120 cisterns
- Compatible with pneumatic flush plates



## ProSys™ Electronic Conversion Kit 120 – Sensor



Model	Ref
Conversion Kit 120 NT S	R015867

- Conversion from mechanical to electronic actuation sensor operated flushplates Symfo™ and Altes™
- Pre-installation of electric connection is needed for connection to mains
- Supplied with transformer to convert mains voltage to extra low voltage for optimum safety
- Compatible with ProSys™ 120 cisterns



## ProSys™ Electronic Conversion Kit 120 – Infrared



Model	Ref
Conversion Kit 120 NT IR	R009967

- Conversion from mechanical to electronic actuation infrared operated flushplates Septa Pro™ E1 and E2
- Pre-installation of electric connection is needed for connection to mains
- Transformer is supplied with Septa Pro™ E1 and E2 flushplates
- Compatible with ProSys™ 120 cisterns



## ProSys™ SmartForce Kit 120



Model	Ref
SmartForce Kit 120	R015767

- Conversion from mechanical to electronic actuation (SmartForce)
- Hydroelectric generator (no connection to mains or replacement of batteries required)
- Storage temperature between: -25° and 65°C
- Degree of protection for the hydroelectric generator: IP67
- Degree of protection for the connection cable: IP67
- Small particle filter integrated in the generator inlet
- Connection to the water supply
- Maximum pressure: < 10bar
- Operating pressure between: 0 and 10 bar
- Operating temperature between: -5° and 55°C
- LiFePO4 rechargeable battery with energy management and protection circuit
- Battery capacity: 2750mAh
- Battery supply voltage 6,5Vdc
- 2 pole KCC compatible cables, for power supply and charging
- Compatible with ProSys™ 120 cisterns
- Compatible with no-touch sensor flush plates

# Technical information



## ProSys™ Pneumatic Conversion Kit 80



Model	Ref
Conversion Kit 80 P	R014967

- Conversion from mechanical to pneumatic actuation
- 2 x 350mm pneumatic pipes
- Outlet valve pneumatic anchors
- Pneumatic bellows
- Compatible with ProSys™ 80 cisterns



## ProSys™ Electronic Conversion Kit 80 – Sensor



Model	Ref
Conversion kit 80 NT S	R015067

- Conversion from mechanical to electronic actuation sensor operated flushplates Symfo™ and Altes™
- Pre-installation of electric connection is needed for connection to mains
- Supplied with transformer to convert mains voltage to extra low voltage for optimum safety
- Compatible with ProSys™ 80 cisterns





## ProSys™ Electronic Conversion Kit 80 – Infrared



Model	Ref
Conversion Kit 80 NT IR	R015167

- Conversion from mechanical to electronic actuation infrared operated flushplates Septa Pro™ E1 and E2
- Pre-installation of electric connection is needed for connection to mains
- Transformer is supplied with Septa Pro™ E1 and E2 flushplates
- Compatible with ProSys™ 80 cisterns



## ProSys™ SmartForce Kit 80



Model	Ref
SmartForce Kit 80	R019167

- Conversion from mechanical to electronic actuation (SmartForce)
- Hydroelectric generator (no connection to mains or replacement of batteries required)
- Storage temperature between: -25° and 65°C
- Degree of protection for the hydroelectric generator: IP67
- Degree of protection for the connection cable: IP67
- Small particle filter integrated in the generator inlet
- Connection to the water supply
- Maximum pressure: < 10bar
- Operating pressure between: 0 and 10bar
- Operating temperature between: -5° and 55°C
- LiFePO4 rechargeable battery with energy management and protection circuit
- Battery capacity: 2750mAh
- Battery supply voltage 6,5Vdc
- 2 pole KCC compatible cables, for power supply and charging
- Compatible with ProSys™ 80 cisterns
- Compatible with no-touch sensor flush plates

# Technical information



## ProSys™ Pneumatic Conversion Kit 150



Model	Ref
Conversion Kit 150 P	R009267

- Conversion from mechanical to pneumatic actuation
- 2 x 350mm pneumatic pipes
- Outlet valve pneumatic anchors
- Pneumatic bellows
- Compatible with ProSys™ 150 cisterns



## ProSys™ Top Actuation Conversion Kit 150

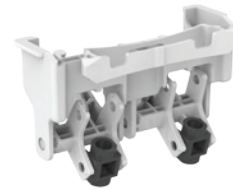

Model	Ref
Conversion Kit 150 M T	R017667

- Conversion from mechanical front actuation to top actuation
- Compatible with ProSys™ 150 cisterns
- Compatible with mechanical Oleas™ flush plates



---

## ProSys™ SmartFlush Kit



Model	Ref
SmartFlush Kit	R018667

- 
- Simple refilling system through a control plate of the cistern
  - Compatible with ProSys™ 120, 80 and 150 cisterns
  - Compatible with Oleas™ SmartFlush flush plates
  - Compatible with all the existing detergents on the market (the use of chlorine-free liquid detergents with a viscosity between 150 and 300 cp (at 20° C) is recommended)
  - Storage capacity: 450ml



Ideal Standard

**Ideal Standard-Vidima AD**

53 Marin Popov Street  
5400 Sevlievo, Bulgaria  
Tel: +359 675 30362  
office@idealstandard.com

**Representative office, Riga**

A. Briana str. 9a,  
Riga, LV- 1001, Latvia  
Tel: +371 673 57 792  
Fax: +371 673 57 795  
VDorogoi@IdealStandard.com

**Representative Office, Bucharest**

Cotroceni Business Center  
Bd. Iuliu Maniu, nr 7, corp T,  
061072 Bucharest, Romania  
Tel/Fax: +40 21 322 3201  
Tel/Fax: +40 21 322 3202  
OfficeBucharest@idealstandard.com

**Representative office, Belgrade**

Drinčićeva no.19, apartment no.8  
11000 Belgrade, Serbia  
Tel/Fax: +381 11 7138 058  
Tel/Fax: +381 11 7138 059  
OBelgrade@IdealStandard.com

**Representative Office, Budapest**

IS-Hun Kft  
1221 Budapest  
Aranyfácán u 20  
Tel: +36 30 6991 594  
ZGarai@idealstandard.com

**Contact for Albania, Kosovo  
and Bosnia & Herzegovina**

Tel: +359 887 709 696  
IMichev@idealstandard.com

**Contact for Croatia**

Tel: +38591 22 99 304  
HPavicic@idealstandard.com

**Contact for Slovenia**

Tel: +39 040 2158058  
info@liaison.it

[www.idealstandard.com](http://www.idealstandard.com)