

GENERAL CATALOGUE



BUGATTI SANITARY-TAPS

MADE IN ITALY

2021

PRODUZIONE
RUBINETTI
PER CUCINE E BAGNI

 **FARIS**[®]
RUBINETTERIE



Faris Rubinetterie è un marchio di proprietà di:
Bugatti Sanitary Taps S.r.l.
Faris Rubinetterie is a trademark of:
Bugatti Sanitary Taps S.r.l.



BUGATTI SANITARY-TAPS

La Bugatti Sanitary Taps è un'azienda a livello familiare, nata dalla 40ennale esperienza di Domenico Bugatti nel campo della rubinetteria igienico-sanitaria. Avendo acquisito nel 2018 lo storico marchio di rubinetteria Faris rubinetterie, si pone l'obiettivo primario di inserirsi tra le aziende leader del settore a livello nazionale, con prodotti nati per durare nel tempo. La filosofia imprenditoriale di Domenico Bugatti, basata sul concetto di continuità della tradizione nel campo della rubinetteria, ha permesso di concepire prodotti dalle linee attuali e raffinate, veri complementi che si sposano alla perfezione con le diverse tipologie di stili d'arredo.

Bugatti Sanitary Taps is a family-run company born from Domenico Bugatti's 40-years experience in the field of sanitary taps. With the acquisition of the historic brand "Faris", in 2018, Bugatti Sanitary Taps pursues the primary objective of becoming one of the leading Italian companies in this industry, with products manufactured to last over time. Domenico Bugatti's entrepreneurial philosophy, based on the principle of continuity and tradition, has allowed us to design products with modern and refined lines, perfectly fitting with any style of interior design.

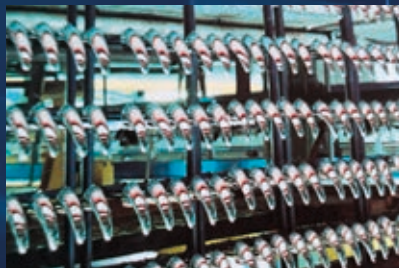

Ogni componente, durante il ciclo produttivo viene sottoposto a severi e ripetuti controlli al fine di garantire il più alto livello di qualità. Il prodotto finito è il risultato dello stile e del design, dell'uso altamente tecnologico degli impianti che unitamente alla capacità creativa rendono il risultato finale di grande soddisfazione.

Throughout the productive cycle, all components are subject to strict repeated controls and testing in order to guarantee their highest quality. The finished product results from a blend of style and design, highly technological production systems and creative capacity, to the customer's greatest satisfaction.



Design 100% made in Italy

100% made in Italy design

Le fasi a più elevato valore aggiunto (ricerca, design, commercializzazione) ci hanno permesso di governare i processi produttivi allo scopo di migliorare sensibilmente la qualità dei prodotti. Tecnologie avanzate, per la progettazione, utilizzo di robotica unitamente alle linee automatizzate di montaggio e collaudo ci consentono di fornire prodotti di elevata qualità. La tecnologia e l'utilizzo dei dischi e vitoni in ceramica di ossido di alluminio ad alta temperatura ci permette di ottenere un grado di affidabilità, durata e resistenza anche a temperature di oltre 90 gradi ed a pressioni superiori a 6 Bar. Il trattamento di cromatura viene eseguito con impianti ad altissima tecnologia, garantendo uno spessore di 0,25 micron, rispondendo così ad una esigenza di costante qualità del trattamento.

We have guided the productive processes through research, design and marketing, with the purpose of significantly improve product quality. Advanced technologies, CAD systems, robotics, automatic assembly and testing lines have enabled us to supply high quality products. The use of disks and head valves in high-temperature aluminium oxide ceramics enable us to obtain reliable, durable and tough products that withstand temperatures above 90 degrees and pressure above 6 bar. The chromium plating treatment is performed by state-of-the-art systems to obtain 0.25 micron-thick coats and thus meet the need for a consistent quality finish.



Marcatura laser

Laser marking

La nostra azienda, su richiesta del cliente, può realizzare la personalizzazione del miscelatore attraverso l'incisione laser del Vostro logo o di qualsiasi altro disegno in formato vettoriale. La marcatura viene eseguita su tutti i tipi di finitura.

Upon customer's request, our company can customize the mixer through laser engraving of your logo or any other marking in vector format. Customized marking is available for all types of finish.

Finiture disponibili

Available finishes

00

Cromo **Chrome**

20

Cromo Oro **Chrome gold**

08

Bianco Cromo **White Chrome**

28

Bianco Oro **White Gold**

13













Oro **Gold**

18

Bronzo **Bronze**

Serie

Series

 <p>Thin</p>	10	 <p>Quadric</p>	16	 <p>Futurist</p>	22		
 <p>Arial</p>	30	 <p>Colonial</p>	34	 <p>Panther</p>	40		
 <p>Elite</p>	52	 <p>Teco</p>	60	 <p>Liberty</p>	66		
 <p>Cucine</p>	80	 <p>Quick</p>	88	 <p>Parrucchiere</p>	92	 <p>Accessori</p>	96

Indice alfabetico

alphabetical order



- Miscelatori monocomando con cartuccia ø 25 mm
Single-lever mixers with ø 25 mm cartridge
- 10 Thin
-
- Miscelatori monocomando con cartuccia ø 35 mm
Single-lever mixers with ø 35 mm cartridge
- 16 Quadric
22 Futurist
30 Arial
34 Colonial
40 Panther
-
- Miscelatori monocomando con cartuccia ø 40 mm
Single-lever mixers with ø 40 mm cartridge
- 52 Elite
60 Teco
-
- Serie tradizionali
Traditional ranges
- 66 Liberty
-
- 80 Miscelatori per cucina
Kitchen sink mixers
- 88 Quick
-
- 92 Rubinetteria per lavatesta parrucchieri
Hairdresser single-lever mixer
-
- 96 Accessori e ricambi
Accessories and spare parts
- 98 Flessibili flexible Flexible hoses
- 100 Docce Handshowers
- 104 Supporti doccia Shower supports
- 105 Saliscendi Slide rails
- 108 Prese acqua Water plugs
- 109 Bracci doccia con soffione Shower arms with shower head
- 111 Eccentrici Eccentrics
- 113 Collegamenti Connections
- 114 Rubinetti sottolavabo Angle taps
- 115 Scarichi Pop-up wastes
- 117 Tappi Water plugs
- 118 Sifoni & pilette Traps & drains
- 119 Bocche di erogazione Spouts
- 123 Aeratori Aerators
- 125 Deviatori Diverters
- 126 Basette Base rings
- 127 Cartucce Cartridges
- 130 Prolunghe Extensions
- 131 Piastre Plates
- 134 Guarnizioni o-rings & anelli teflon
O-ring gaskets and teflon rings
- 136 Set fissaggio Fixing set
- 137 Piantane Lateral connections
- 137 Valvole Valves
-
- 138 Condizioni generali di vendita
General sales conditions

THIN

COLLEGAMENTI:

I monocomando per lavabo e bidet sono forniti completi con coppia flessibili acciaio inox art. 703 lunghezza 35 cm attacco G. 3/8" F. A richiesta G. 1/2" F. **La serie THIN è fornita con cartucce:**

Ø 30	TH100 + TH100D	TH100	TH400+TH100D	TH400
Ø 25	TH200	TH250	TH300	
Ø 35	TH410	TH420	TH110	

CONNECTIONS:

The single lever basin, and bidet mixers are supplied complete with stainless steel flexible hoses item 703, lenght 35 cm with. 3/8" F GT connection. On request G. 1/2" F. **The THIN series is supplied with cartridges:**

Ø 30	TH100 + TH100D	TH100	TH400+TH100D	TH400
Ø 25	TH200	TH250	TH300	
Ø 35	TH410	TH420	TH110	

 **FARIS**[®]
RUBINETTERIE

 **BUGATTI**
SANITARY-TAPS



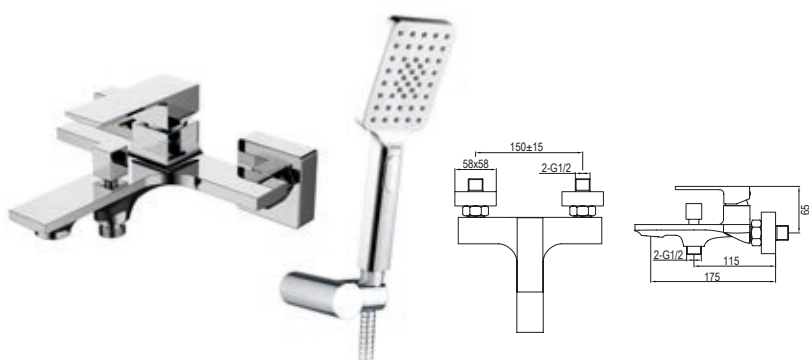

TH100D

Monocomando vasca con kit doccia.
Single-lever bath mixer with handshower and 150 cm flexible hose.

00 cromo chrome € 175,00

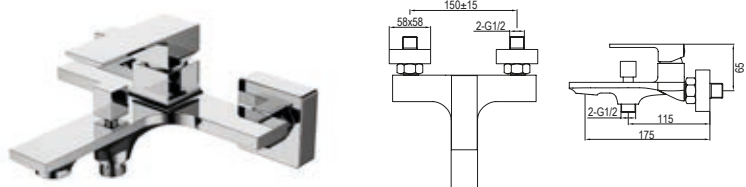

TH100

Monocomando vasca senza kit doccia.
Single-lever bath mixer.

00 cromo chrome € 157,00

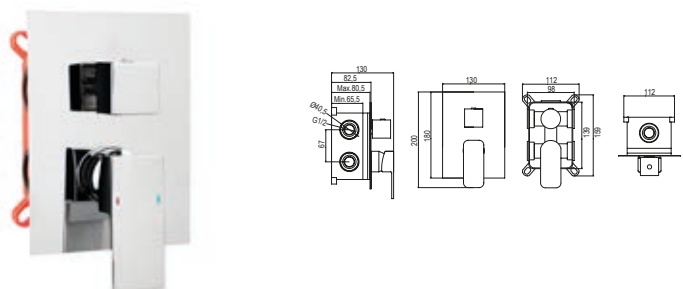

TH110

Monocomando incasso vasca/doccia.
Built in single-lever bath/shower mixer.

00 cromo chrome € 168,00

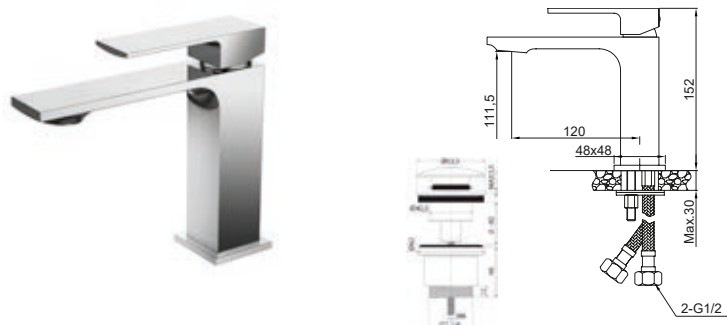

TH200

Monocomando lavabo con scarico click-clack 1"1/4.
Single-lever basin mixer with pop-up waste 1"1/4.

00 cromo chrome € 140,00

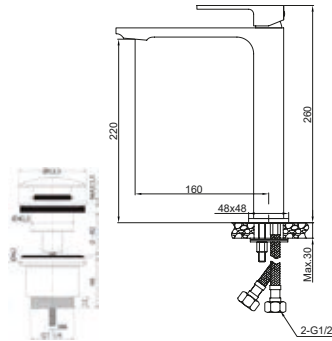

TH250

Monocomando lavabo alto con scarico click-clack 1" 1/4.
High single lever basin mixer with pop-up waste 1" 1/4.

00 cromo chrome € 192,00

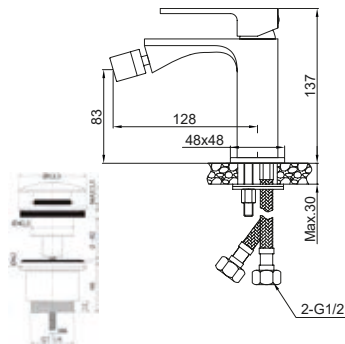

TH300

Monocomando bidet con scarico click-clack 1" 1/4.
Single lever bidet mixer with pop-up waste 1" 1/4.

00 cromo chrome € 145,00

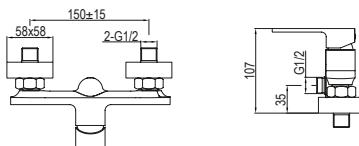

TH400D

Monocomando doccia esterno con kit doccia.
Single-lever shower mixer with handshower and 150 cm flexible hose.

00 cromo chrome € 147,00

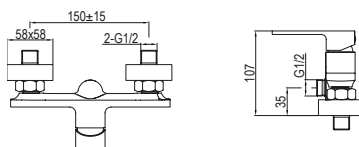

TH400

Monocomando doccia esterno senza kit doccia.
Single lever shower mixer.

00 cromo chrome € 129,00

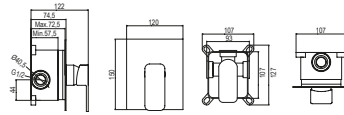

TH410

Monocomando incasso doccia.
Built-in single-lever shower mixer.

00 cromo chrome € 133,00

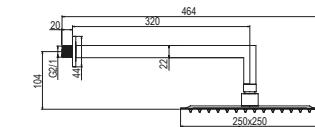

TH420

Monocomando incasso doccia con deviatore completo di doccia duplex con presa acqua, braccio e soffione anticalcare 25 x 25 cm.

Single-lever built-in shower mix with diverter, handshower water plug with shower support, 150 cm flexible hose, shower arm 25 x 25 cm anti-lime system shower head.

00 cromo chrome € 332,00

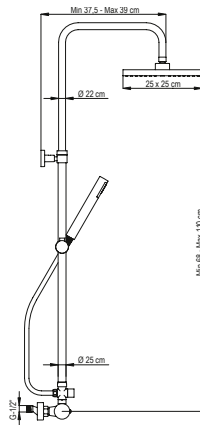
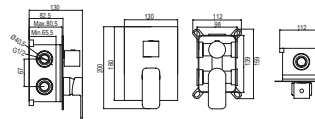

TH450

Termostatico per sistema doccia, barra telescopica in acciaio inossidabile regolabile min 68 cm max 110 cm; soffione regolabile in ABS 25x25 cm anticalcare; doccetta anticalcare. Supporto scorrevole e orientabile, flessibile in PVC argento, deviatore in ottone cromato con vitone ceramico.

Thermostatic shower system, stainless steel adjustable telescope bar min 68 cm max 110 cm; 25x25 cm adjustable ABS shower head anti-lime system. Handshower anti-lime system, sliding support and adjustable flexible in silver PVC diverter in chromed brass with ceramic head.

00 cromo chrome € 400,00

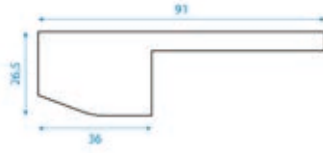

TH1000

Leva in metallo serie "Thin".
Metal lever for range "Thin".

00 cromo [chrome](#) € 12,00

QUADRIC

 **FARIS**[®]
RUBINETTERIE

 **BUGATTI**
SANITARY-TAPS



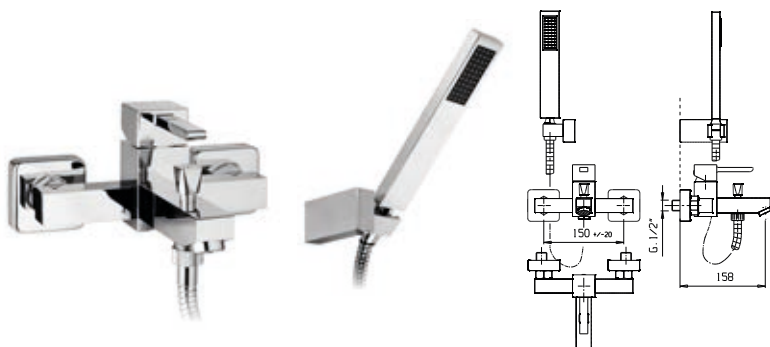

16000

Monocomando vasca esterno completo di doccia, supporto e flessibile 150 cm.

Single lever bath mixer with handshower and 150 cm. flexible hose.

00 cromo chrome € 216,00

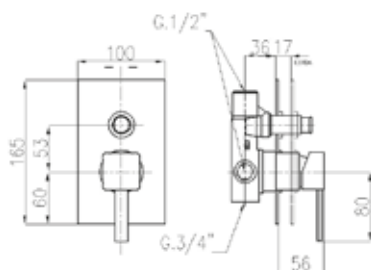

16091

Monocomando incasso vasca/doccia.

Built in single lever bath/shower.

00 cromo chrome € 150,00

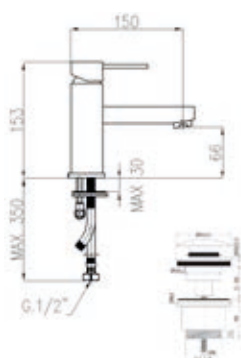

16100

Monocomando lavabo con scarico click-clack 1"1/4.

Single lever basin mixer with pop-up waste 1"1/4.

00 cromo chrome € 150,00

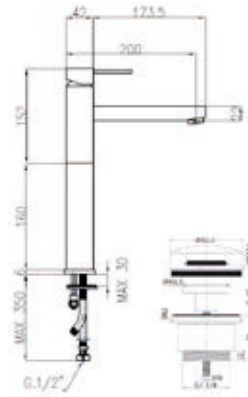

16150

Monocomando lavabo alto con bocca fissa e scarico click-clack 1" 1/4.

High single lever basin mixer with fixed spout and pop-up waste 1" 1/4.

00 cromo chrome € 250,00

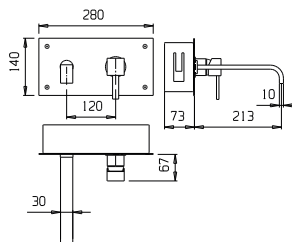

16190

Monocomando incasso lavabo.

Built-in single lever basin mixer.

00 cromo chrome € 320,00

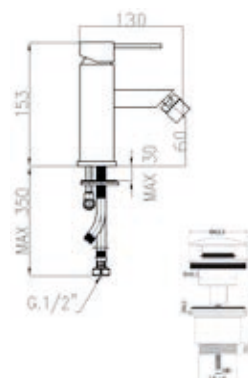

16200

Monocomando bidet completo di scarico click-clack 1" 1/4.

Single lever bidet mixer with pop-up waste 1" 1/4.

00 cromo chrome € 156,00



16300

Monocomando doccia esterno completo di doccia, supporto e flessibile 150 cm.

Single lever shower with handshower, support and 150 cm. flexible hose.

00 cromo chrome € 196,00

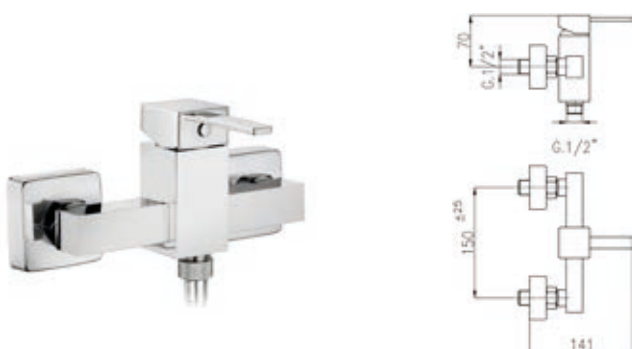

16400

Monocomando doccia esterno.

Single-lever shower mixer.

00 cromo chrome € 140,00

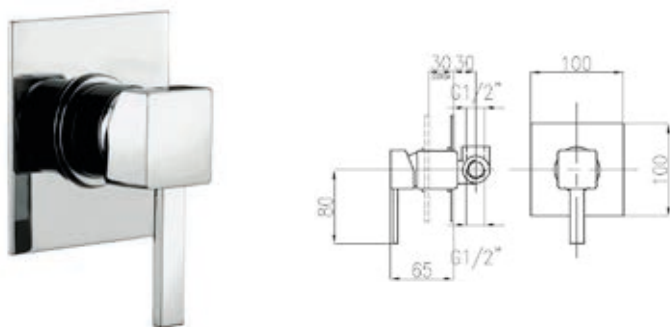

16500

Monocomando incasso doccia.

Built in single lever shower mixer.

00 cromo chrome € 104,00

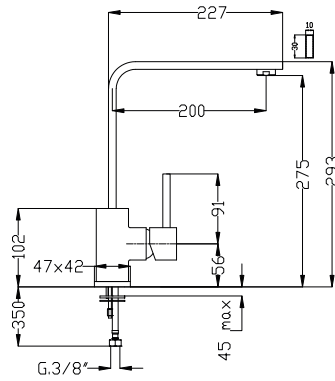

16720

Monocomando lavello con bocca girevole.
Single lever sink mixer with swivel spout.

00 cromo chrome € 195,00

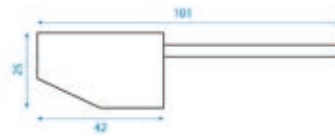

16900

Leva in metallo per serie "Quadric".
Metal lever for range "Quadric".

00 cromo chrome € 12,00

FUTURIST

 **FARIS**[®]
RUBINETTERIE

 **BUGATTI**
SANITARY-TAPS





13000

Monocomando vasca esterno completo di doccia, supporto e flessibile cm. 150.

Single lever bath mixer with handshower, support and 150 cm. flexible hose.

00 cromo chrome € 128,00



13050

Monocomando vasca esterno.

Single-lever bath mixer.

00 cromo chrome € 114,00

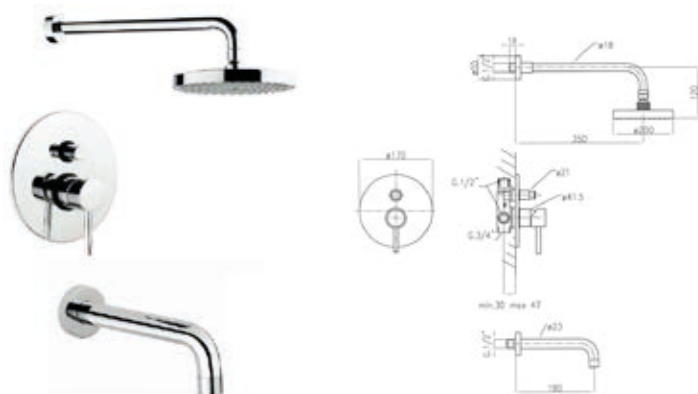

13062

Monocomando incasso vasca/doccia completo di braccio, soffione tondo Ø 200 mm.

Built in single lever bath/shower mixer with shower arm, and Ø 200 mm round shower head.

00 cromo chrome € 340,00



13070

Monocomando incasso vasca/doccia.

Built in single lever bath/shower.

00 cromo chrome € 110,00

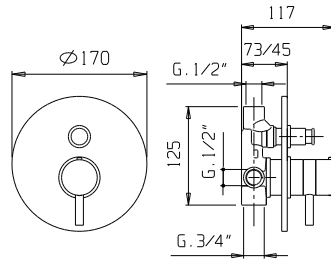

13075

Monocomando incasso vasca/doccia con cartuccia termostatica.
Built-in thermostatic shower/bath mixer with diverter.

00 cromo chrome € 305,00

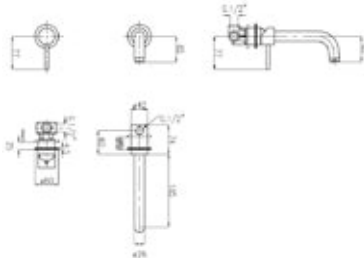

13080

Monocomando da incasso per lavabo.
Built in single lever basin mixer.

00 cromo chrome € 138,00

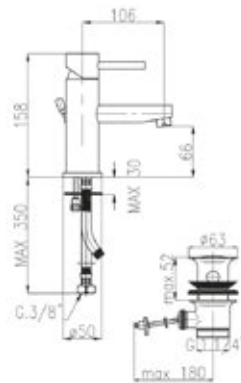

13150

Monocomando lavabo alto completo di scarico 1"1/4.
High single lever basin mixer with 1"1/4 pop-up waste.

00 cromo chrome € 88,00

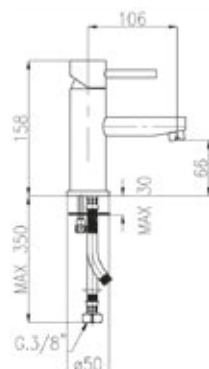

13160

Monocomando lavabo alto senza scarico.
High single lever basin mixer without pop up waste.

00 cromo chrome € 76,00

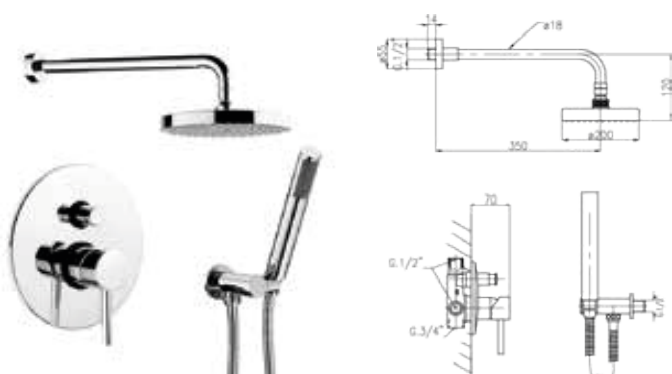

13555

Monocomando incasso vasca/doccia con deviatore a 2 vie completo di doccia duplex con presa acqua, braccio e soffione tondo Ø 200 mm.

Single lever built in shower mixer with diverter, hand-shower, water connection with bracket, 150 Cm flexible hose, shower arm Ø 200 mm round shower head.

00 cromo chrome € 400,00



13600

Monocomando lavello con bocca girevole.

Single lever sink mixer with swivel spout.

00 cromo chrome € 90,00



13650

Monocomando lavello alto con bocca girevole.

High single lever sink mixer with swivel spout.

00 cromo chrome € 150,00



13805

Monocomando lavello sottofinestra con bocca girevole abbattibile.

Below window single lever sink mixer with folding spout.

00 cromo chrome € 135,00

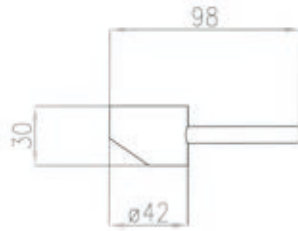

14000

Maniglia in metallo.
Metal lever.

00 cromo chrome € 000,00

ARIAL

COLLEGAMENTI:

I monocomando per lavabo e bidet sono forniti completi con coppia flessibili acciaio inox art. 703 lunghezza 35 cm attacco G. 3/8" F. A richiesta G. 1/2" F. La serie ARIAL è fornita con cartucce Ø 35.

CONNECTIONS:

The single lever basin and bidet mixers are supplied complete with stainless steel flexible hoses item. 703, length 35 cm with 3/8" F GT connection. On request G. 1/2" F. The ARIAL series is supplied with Ø 35 cartridges.

 **FARIS**[®]
RUBINETTERIE

 **BUGATTI**
SANITARY-TAPS



**12000**

Monocomando vasca esterno con doccia e flessibile 150 cm.

Single-lever bath mixer with handshower and 150 cm flexible hose.

00 cromo chrome € 186,00

**12050**

Monocomando vasca esterno.

Single-lever bath mixer.

00 cromo chrome € 171,00

**12091**

Monocomando incasso vasca/doccia.

Built single-lever bath/shower mixer with diverter.

00 cromo chrome € 120,00

**12100**

Monocomando lavabo con scarico 1" 1/4.

Single-lever basin mixer with 1" 1/4 pop-up waste.

00 cromo chrome € 132,00

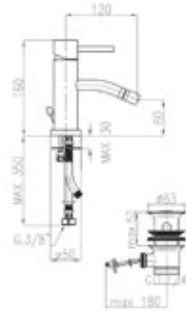

12200

Monocomando bidet con scarioco 1"1/4.
Single-lever bidet mixer with 1"1/4 pop-up waste.

00 cromo chrome € 137,00

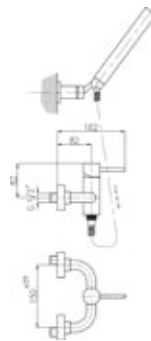

12300

Monocomando doccia esterno on doccia e flessibile 150 cm.
Single-lever shower mixer with handshower and 150 cm flexible hose.

00 cromo chrome € 151,00

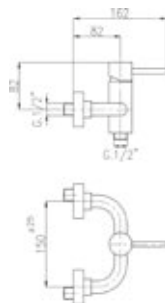

12400

Monocomando doccia esterno.
Single-lever shower mixer.

00 cromo chrome € 136,00

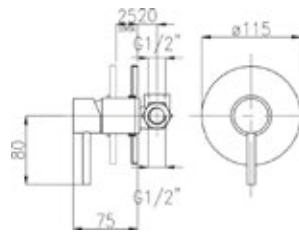

12500

Monocomando incasso doccia.
Built-in single-lever shower mixer.

00 cromo chrome € 72,00

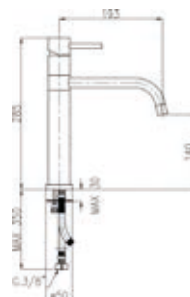

12600

Monocomando lavello con bocca girevole.
Single-lever sink mixer with swivel spout.

00 cromo chrome € 120,00

COLONIAL

COLLEGAMENTI:

I monocomando per lavabo e bidet sono forniti completi con coppia flessibili acciaio inox art. 703 lunghezza 35 cm attacco GT 3/8" F. A richiesta G. 1/2" F. La serie COLONIAL è fornita con cartucce Ø 35 mm.

CONNECTIONS:

The single lever basin and bidet mixers are supplied complete with stainless steel flexible hoses item. 703, length 35 cm with 3/8" F GT connection. On request G. 1/2" F. The COLONIAL series is supplied with Ø 35 cartridges.

 **FARIS**[®]
RUBINETTERIE

 **BUGATTI**
SANITARY-TAPS





7000

Monocomando vasca esterno con doccia e flessibile cm.150.
Single-lever bath mixer with handshower and 150 cm.
flexible hose.

00	cromo	chrome	€ 160,00
20	cromo-oro	chrome-gold	€ 210,00
08	bianco-cromo	white-chrome	€ 194,00
28	bianco-oro	white-gold	€ 210,00
13	oro	gold	€ 260,00
18	bronzo	bronze	€ 260,00



7050

Monocomando vasca esterno.
Single-lever bath mixer.

00	cromo	chrome	€ 112,00
20	cromo-oro	chrome-gold	€ 145,00
08	bianco-cromo	white-chrome	€ 134,00
28	bianco-oro	white-gold	€ 145,00
13	oro	gold	€ 179,00
18	bronzo	bronze	€ 179,00



7060

Monocomando bordo vasca 3 fori con doccia.
3-hole bath single-lever mixer with handshower.

00	cromo	chrome	€ 204,00
20	cromo-oro	chrome-gold	€ 265,00
08	bianco-cromo	white-chrome	€ 245,00
28	bianco-oro	white-gold	€ 265,00
13	oro	gold	€ 326,00
18	bronzo	bronze	€ 326,00

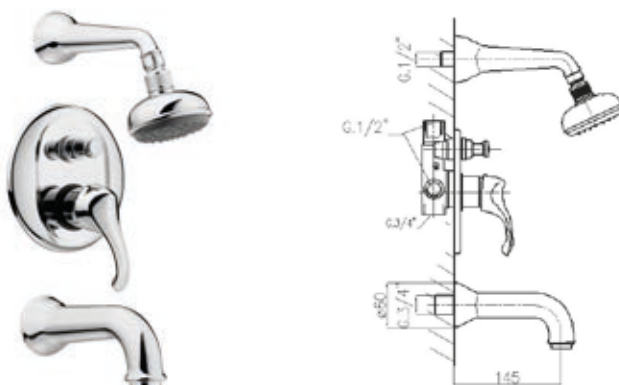

7080

Monocomando incasso vasca/doccia con soffione
orientabile anticalcare.

Built-in single lever bath/shower with adjustable
shower head antiscaling system.

00	cromo	chrome	€ 230,00
20	cromo-oro	chrome-gold	€ 300,00
08	bianco-cromo	white-chrome	€ 276,00
28	bianco-oro	white-gold	€ 300,00
13	oro	gold	€ 368,00
18	bronzo	bronze	€ 368,00

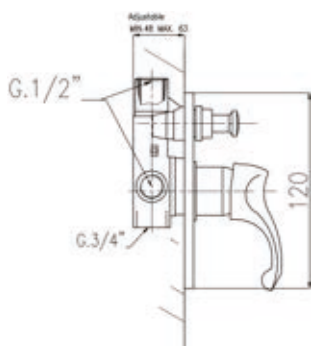

7091

Monocomando incasso vasca/doccia.
Built-in single-lever bath/shower mixer.

00	cromo	chrome	€ 110,00
20	cromo-oro	chrome-gold	€ 143,00
08	bianco-cromo	white-chrome	€ 132,00
28	bianco-oro	white-gold	€ 143,00
13	oro	gold	€ 176,00
18	bronzo	bronze	€ 176,00

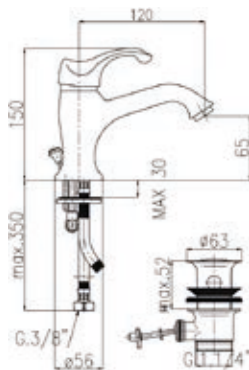

7100

Monocomando lavabo con scarico 1"1/4.
Single-lever basin mixer with 1" 1/4 pop-up waste.

00	cromo	chrome	€ 94,00
20	cromo-oro	chrome-gold	€ 122,00
08	bianco-cromo	white-chrome	€ 113,00
28	bianco-oro	white-gold	€ 122,00
13	oro	gold	€ 150,00
18	bronzo	bronze	€ 150,00

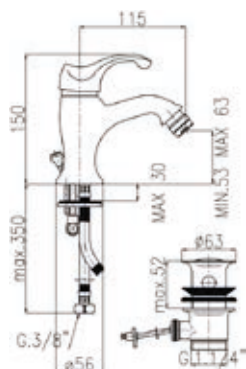

7200

Monocomando bidet con scarico 1"1/4.
Single-lever bidet mixer with 1" 1/4 pop-up waste.

00	cromo	chrome	€ 96,00
20	cromo-oro	chrome-gold	€ 125,00
08	bianco-cromo	white-chrome	€ 115,00
28	bianco-oro	white-gold	€ 125,00
13	oro	gold	€ 154,00
18	bronzo	bronze	€ 154,00

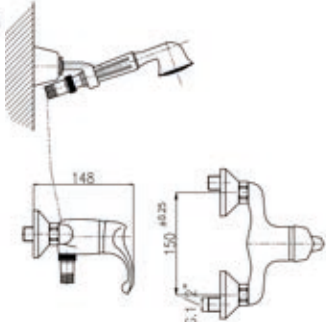

7300

Monocomando doccia esterno con doccia e flessibile 150 cm.
Single-lever shower mixer with handshower and 150 cm flexible hose.

00	cromo	chrome	€ 140,00
20	cromo-oro	chrome-gold	€ 182,00
08	bianco-cromo	white-chrome	€ 168,00
28	bianco-oro	white-gold	€ 182,00
13	oro	gold	€ 224,00
18	bronzo	bronze	€ 224,00

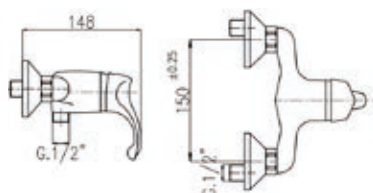

7400

Monocomando doccia esterno.
Single-lever shower mixer.

00	cromo	chrome	€ 92,00
20	cromo-oro	chrome-gold	€ 120,00
08	bianco-cromo	white-chrome	€ 110,00
28	bianco-oro	white-gold	€ 120,00
13	oro	gold	€ 147,00
18	bronzo	bronze	€ 147,00

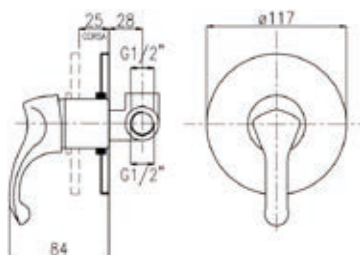

7500

Monocomando incasso doccia.
Built-in single-lever shower mixer.

00	cromo	chrome	€ 62,00
20	cromo-oro	chrome-gold	€ 81,00
08	bianco-cromo	white-chrome	€ 75,00
28	bianco-oro	white-gold	€ 81,00
13	oro	gold	€ 99,00
18	bronzo	bronze	€ 99,00

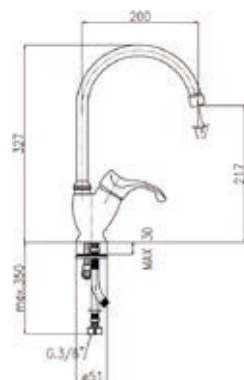

7650

Monocomando lavello con bocca alta girevole Ø18 art.066.
Single-lever sink mixer with Ø 180 mm high swivel
spout item 066.

00	cromo	chrome	€ 92,00
20	cromo-oro	chrome-gold	€ 120,00
08	bianco-cromo	white-chrome	€ 110,00
28	bianco-oro	white-gold	€ 120,00
13	oro	gold	€ 147,00
18	bronzo	bronze	€ 147,00

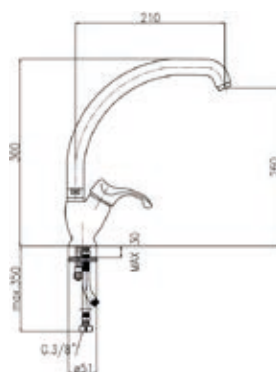

7660

Monocomando lavello con bocca alta in tubo (art.074).
Single-lever sink mixer with high tubular swivel spout
(art.074) shower.

00	cromo	chrome	€ 116,00
20	cromo-oro	chrome-gold	€ 151,00
08	bianco-cromo	white-chrome	€ 140,00
28	bianco-oro	white-gold	€ 151,00
13	oro	gold	€ 186,00
18	bronzo	bronze	€ 186,00

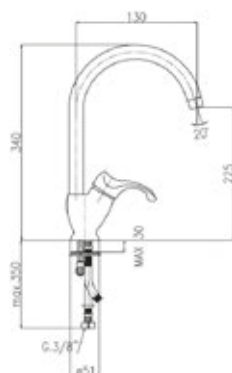

7670-70

Monocomando lavello con bocca girevole a C Ø 25 art. 070.
Single-lever sink mixer with "C" Ø 25 mm mixer item 070.

00	cromo	chrome	€ 106,00
20	cromo-oro	chrome-gold	€ 138,00
08	bianco-cromo	white-chrome	€ 127,00
28	bianco-oro	white-gold	€ 138,00
13	oro	gold	€ 170,00
18	bronzo	bronze	€ 170,00



7670-72

Monocomando lavello con bocca girevole alta a "C" Ø25 mm art.072.
Single-lever sink mixer with "C" high Ø 25 mm swivel spout item 072.

00	cromo	chrome	€ 110,00
20	cromo-oro	chrome-gold	€ 143,00
08	bianco-cromo	white-chrome	€ 132,00
28	bianco-oro	white-gold	€ 143,00
13	oro	gold	€ 176,00
18	bronzo	bronze	€ 176,00

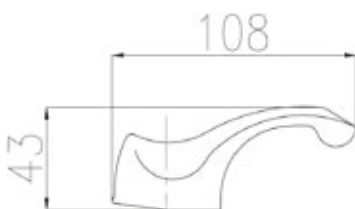

7800

Leva in metallo "Colonial".
"Colonial" metal lever.

00	cromo	chrome	€ 8,00
20	cromo-oro	chrome-gold	€ 10,40
08	bianco-cromo	white-chrome	€ 10,00
28	bianco-oro	white-gold	€ 10,40
13	oro	gold	€ 13,00
18	bronzo	bronze	€ 13,00

PANTHER

COLLEGAMENTI:

I monocomando per lavabo e bidet sono forniti completi con coppia flessibili acciaio inox art. 703 lunghezza 35 cm attacco G. 3/8" F. A richiesta G. 1/2" F.

La serie PANTHER è fornita con cartucce Ø 35.

CONNECTIONS:

The single lever basin and bidet mixers are supplied complete with stainless steel flexible hoses item. 703, length 35 cm with 3/8" F GT connection. On request G. 1/2" F.

The PANTHER series is supplied with Ø 35 cartridges.

 **FARIS**[®]
RUBINETTERIE

 **BUGATTI**
SANITARY-TAPS





1050

Monocomando bordo vasca con doccia e flessibile 150 cm.
Bath edge single-lever mixer with handshower and 150 cm flexible hose.

00	cromo	chrome	€ 79,00
20	cromo-oro	chrome-gold	€ 102,00
08	bianco-cromo	white-chrome	€ 94,00

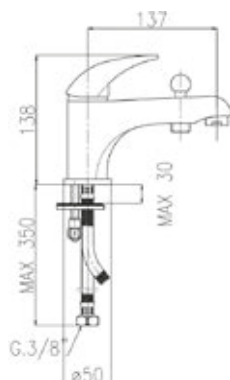

1052

Monocomando bordo vasca.
Bath edge single-lever mixer.

00	cromo	chrome	€ 65,00
20	cromo-oro	chrome-gold	€ 84,00
08	bianco-cromo	white-chrome	€ 78,00

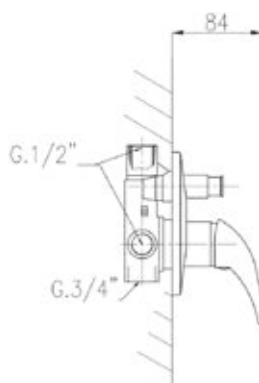

1054

Monocomando incasso doccia/vasca.
Built-in single lever bath/shower.

00	cromo	chrome	€ 94,00
20	cromo-oro	chrome-gold	€ 119,00
08	bianco-cromo	white-chrome	€ 113,00



1060

Monocomando vasca esterno con doccia e flessibile 120 cm.
Single-lever bath mixer with handshower and 120 cm flexible hose.

00	cromo	chrome	€ 79,00
20	cromo-oro	chrome-gold	€ 103,00
08	bianco-cromo	white-chrome	€ 95,00



1062

Monocomando vasca esterno con doccia, supporto regolabile e flessibile cm. 150.

Single-lever bath mixer with handshower adjustable shower bracket and 150 cm. flexible hose.

00	cromo	chrome	€ 84,00
20	cromo-oro	chrome-gold	€ 109,00
08	bianco-cromo	white-chrome	€ 101,00



1064

Monocomando vasca esterno.

Single-lever bath mixer.

00	cromo	chrome	€ 70,00
20	cromo-oro	chrome-gold	€ 91,00
08	bianco-cromo	white-chrome	€ 84,00



1065

Monocomando vasca esterno con deviatore (art.0396) bocca girevole Ø18 lunga 300 mm, doccia e flessibile 150 cm.

Single-lever bath mixer with diverter (art.0396) Ø 18 mm and 300 mm long swivel spout, handshower and 150 cm flexible hose.

00	cromo	chrome	€ 92,00
20	cromo-oro	chrome-gold	€ 120,00
08	bianco-cromo	white-chrome	€ 110,00



1068

Monocomando lavabo con scarico 1"1/4.

Single-lever basin mixer with 1"1/4 pop-up waste.

00	cromo	chrome	€ 56,00
20	cromo-oro	chrome-gold	€ 73,00
08	bianco-cromo	white-chrome	€ 68,00

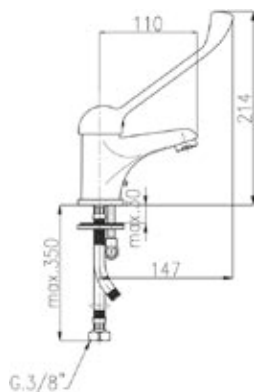
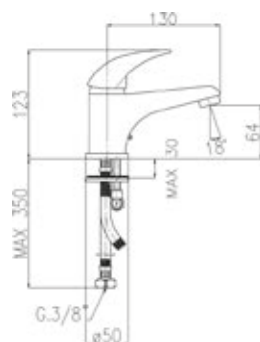
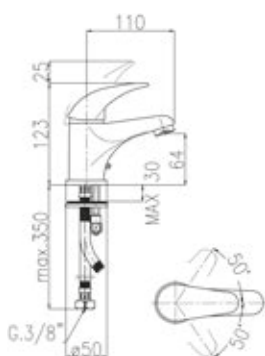
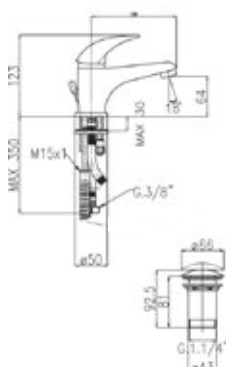

1068-130

Monocomando lavabo con bocca 130 mm e scarico 1"1/4.
Single-lever basin mixer with 130 mm spout and 1"1/4 pop-up waste.

00	cromo	chrome	€ 58,00
20	cromo-oro	chrome-gold	€ 76,00
08	bianco-cromo	white-chrome	€ 70,00

1069

Monocomando lavabo senza scarico con portacatenella.
Single-lever basin mixer without pop-up waste with chain holder.

00	cromo	chrome	€ 44,00
20	cromo-oro	chrome-gold	€ 58,00
08	bianco-cromo	white-chrome	€ 53,00

1069-130

Monocomando lavabo con bocca 130 mm senza scarico con portacatenella.
Single-lever basin mixer with 130 mm spout without pop-up waste with chain holder.

00	cromo	chrome	€ 48,00
20	cromo-oro	chrome-gold	€ 60,00
08	bianco-cromo	white-chrome	€ 56,00

1069-LG

Monocomando lavabo senza scarico con leva a gomito e portacatenella.
Single-lever basin mixer without pop-up waste with elbow lever and chain holder.

00	cromo	chrome	€ 55,00
20	cromo-oro	chrome-gold	€ 71,00
08	bianco-cromo	white-chrome	€ 66,00

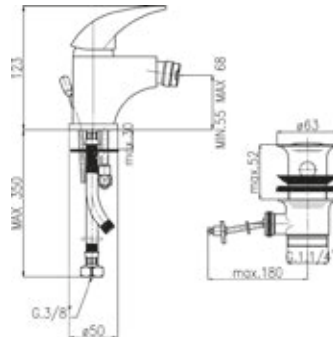

1070

Monocomando bidet con scarico 1" 1/4.
Single-lever bidet mixer with 1" 1/4 pop-up waste.

00	cromo	chrome	€ 59,00
20	cromo-oro	chrome-gold	€ 76,00
08	bianco-cromo	white-chrome	€ 70,00

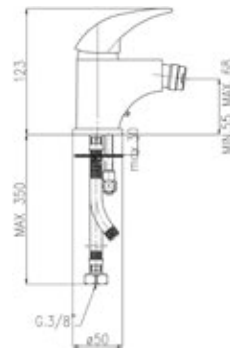

1071

Monocomando bidet senza scarico con portacatenella.
Single-lever bidet mixer without pop-up waste with chain holder.

00	cromo	chrome	€ 47,00
20	cromo-oro	chrome-gold	€ 61,00
08	bianco-cromo	white-chrome	€ 56,00

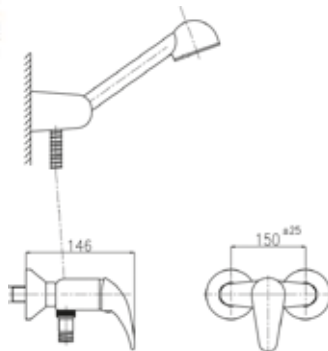

1072

Monocomando doccia esterno con doccia e flessibile 150 cm.
Single-lever shower mixer with handshower and 150 cm flexible hose.

00	cromo	chrome	€ 63,00
20	cromo-oro	chrome-gold	€ 82,00
08	bianco-cromo	white-chrome	€ 75,00

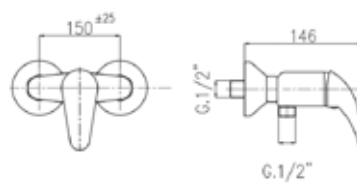

1074

Monocomando doccia esterno.
Single-lever shower mixer.

00	cromo	chrome	€ 49,00
20	cromo-oro	chrome-gold	€ 64,00
08	bianco-cromo	white-chrome	€ 59,00

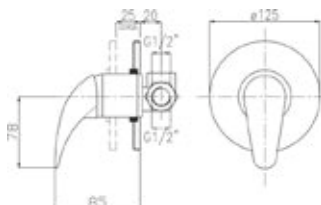

1076

Monocomando incasso doccia.
Built-in single-lever shower mixer.

00	cromo	chrome	€ 44,00
20	cromo-oro	chrome-gold	€ 58,00
08	bianco-cromo	white-chrome	€ 53,00

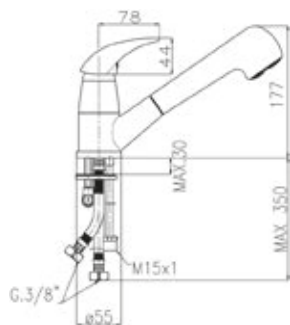

1077

Monocomando lavello con doccia estraibile a due getti e flessibile in nylon rinforzato cm.150.
Single lever sink mixer with removable 2-jet hand shower and nylon 150 cm. flexible hose.

00	cromo	chrome	€ 82,00
----	-------	--------	---------

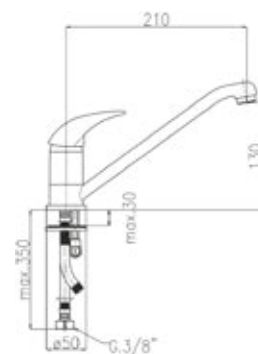

1078

Monocomando lavello con bocca girevole.
Single lever sink mixer with swivel spout.

00	cromo	chrome	€ 43,00
08	bianco-cromo	white-chrome	€ 52,00

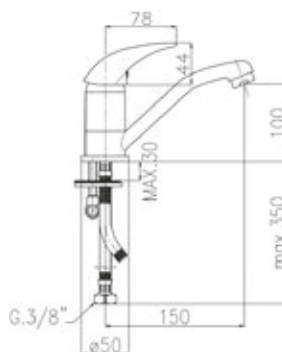

1078-15

Monocomando lavello con bocca girevole.
Single-lever sink mixer with swivel spout.

00	cromo	chrome	€ 43,00
08	bianco-cromo	white-chrome	€ 52,00

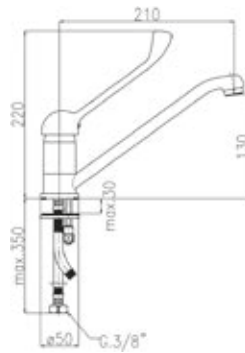

1078-LG

Monocomando livello con bocca girevole 210 mm e leva a gomito.

Single-lever sink mixer with 210 mm swivel spout and elbow lever.

00	cromo	chrome	€ 54,00
20	cromo-oro	white-chrome	€ 64,00

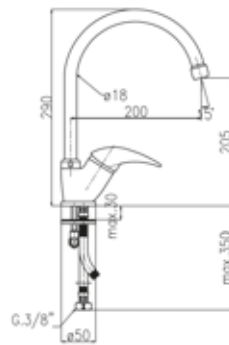

1079

Monocomando livello con bocca girevole art. 066.

Single lever sink mixer with swivel spout 066.

00	cromo	chrome	€ 54,00
08	bianco-cromo	white-chrome	€ 65,00

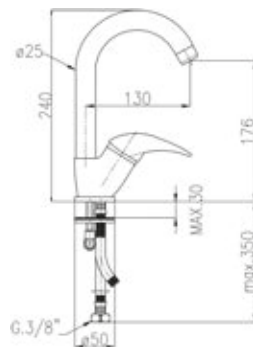

1079-70

Monocomando livello con bocca girevole art. 070.

Single lever sink mixer with swivel spout item 070.

00	cromo	chrome	€ 62,00
08	bianco-cromo	white-chrome	€ 74,00

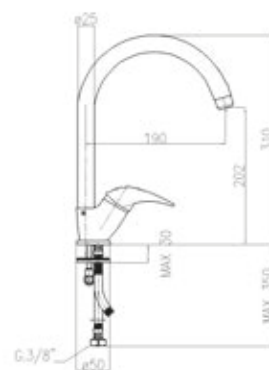

1079-72

Monocomando livello con bocca alta girevole art. 072.

Single lever sink mixer with high swivel spout item 072.

00	cromo	chrome	€ 66,00
08	bianco-cromo	white-chrome	€ 79,00

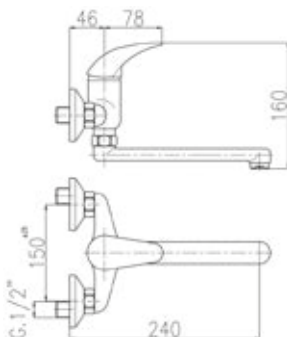
**1080**

Monocomando livello esterno con bocca girevole 200 mm.
Single-lever sink mixer with 200 mm swivel spout.

00	cromo	chrome	€ 65,00
08	bianco-cromo	white-chrome	€ 78,00

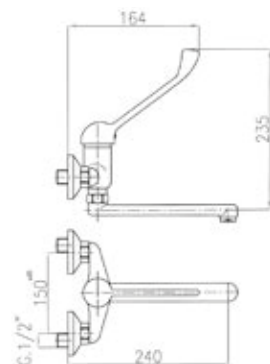
**1080-LG**

Monocomando livello esterno con bocca girevole mm 200 e leva a gomito.
Single-lever sink mixer with 200 mm swivel spout and elbow lever.

00	cromo	chrome	€ 75,00
08	bianco-cromo	white-chrome	€ 90,00

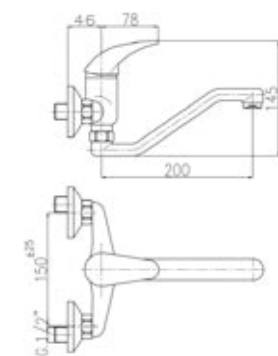
**1081**

Monocomando livello esterno con bocca alta girevole a "S" alzata 200 mm.
Single-lever sink mixer with "S" upward 200 mm swivel spout.

00	cromo	chrome	€ 68,00
08	bianco-cromo	white-chrome	€ 82,00

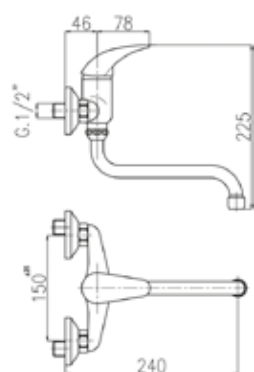
**1082**

Monocomando livello esterno con bocca girevole Ø 18 mm lunga 200 mm.
Single-lever sink mixer with Ø 18 mm and 200 mm long swivel spout.

00	cromo	chrome	€ 60,00
08	bianco-cromo	white-chrome	€ 71,00

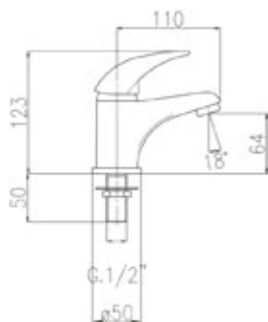

Interasse 100 mm

100 mm connection

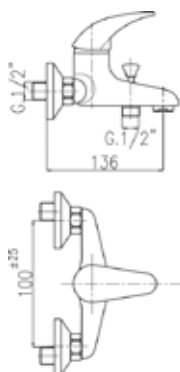
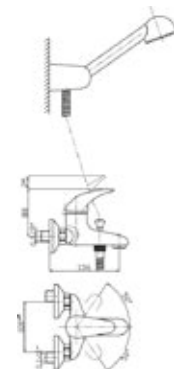
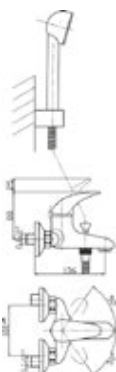

1092

Rubinetto monocomando lavabo acqua fredda attacco da 1/2.

1/2 Single-lever basin cold water tap.

00	cromo	chrome	€ 46,00
08	bianco-cromo	white-chrome	€ 56,00

1060-10

Monoco mando vasca esterno con doccia e flessibile 120 cm.

Single-lever bath mixer with handshower and 120 cm. flexible hose.

00	cromo	chrome	€ 79,00
----	-------	--------	---------

1062-10

Monocomando vasca esterno con doccia, supporto regolabile e flessibile cm.150.

Single-lever bath mixer with handshower, adjustable bracket and 150 cm. Flexible hose, 100 mm connection.

00	cromo	chrome	€ 84,00
----	-------	--------	---------

1064-10

Monocomandom vasca esterno inetrasse 100.

Single-lever bath mixer, 100 mm connection.

00	cromo	chrome	€ 70,00
----	-------	--------	---------

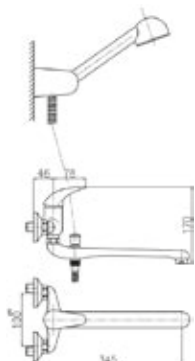
**1066-10**

Monocomando vasca estremo con bocca girevole 300 mm deviatore doccia e flessibile 150 cm. Interasse 100 mm.

Single-lever mixer with 300 mm swivel spout diverter handshower and 150 cm flexible hose, 100 mm connection.

00 cromo chrome € 116,00

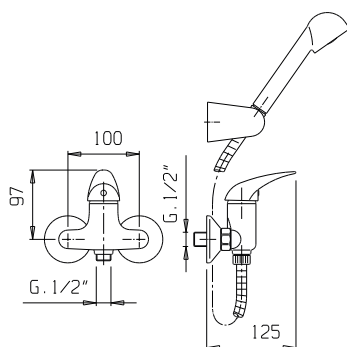
**1072-10**

Monocomando doccia esterno con doccia e flessibile 150 cm. Interasse 100.

Single-lever shower mixer with handshower and 150 cm. flexible hose, 100 mm connection.

00 cromo chrome € 63,00

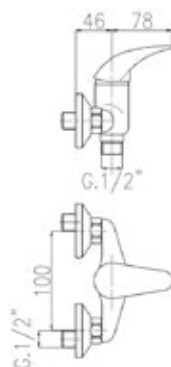
**1074-10**

Monocomando doccia esterno interasse 100 mm.

Single-lever shower mixer 100 mm connection.

00 cromo chrome € 49,00

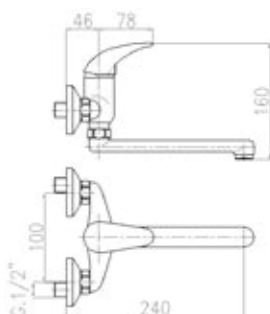
**1080-10**

Monocomando lavello esterno con bocca girevole 200 mm, interasse 100.

Single-lever sink mixer with 200 mm swivel spout, 100 mm connection.

00 cromo chrome € 65,00

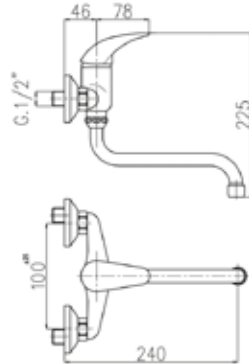

1082-10

Monocomando livello esterno con bocca girevole
Ø18 lunga cm 200 interasse 100 mm.
Single-lever sink mixer with Ø 18 mm and 200 mm
long swivel spout 100 mm connection.

00 cromo chrome € 60,00

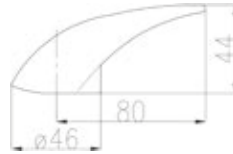

1100

Leva metallo "Rosy".
"Rosy" metal lever.

00 cromo chrome € 5,00

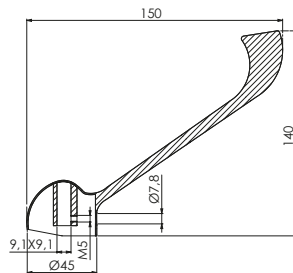

1120

Leva in metallo a gomito "Panther".
"Panther" elbow metal lever.

00 cromo chrome € 16,00

ELITE

COLLEGAMENTI:

Il monocomando per lavabo e bidet sono forniti completi con coppia flessibili acciaio inox art. 703 lunghezza 35 cm attacco G. 3/8" F. A richiesta G. 1/2" F.

La serie ELITE è fornita con cartucce Ø 40.

CONNECTIONS:

The single lever basin and bidet mixers are supplied complete with stainless steel flexible hoses item. 703, length 35 cm with 3/8" F GT connection. On request G. 1/2" F.

The ELITE series is supplied with Ø 40 cartridges.

 **FARIS**[®]
RUBINETTERIE

 **BUGATTI**
SANITARY-TAPS



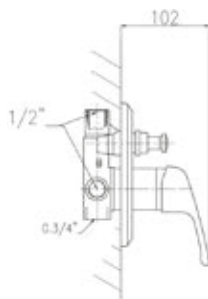

2091

Monocomando incasso vasca/doccia.
Built-in single-lever bath/shower mixer.

00	cromo	chrome	€ 110,00
20	cromo-oro	chrome-gold	€ 143,00
08	bianco-cromo	white-chrome	€ 132,00
28	bianco-oro	white-gold	€ 143,00

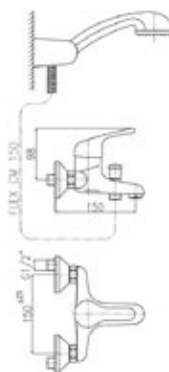

2140

Monocomando vasca esterno con doccia, supporto regolabile e flessibile 150cm.
Single-lever bath mixer with handshower, adjustable shower bracket and 150 cm flexible hose.

00	cromo	chrome	€ 98,00
20	cromo-oro	chrome-gold	€ 128,00
08	bianco-cromo	white-chrome	€ 118,00
28	bianco-oro	white-gold	€ 128,00

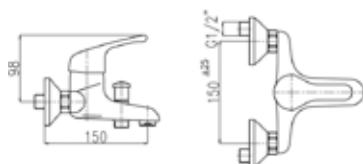

2180

Monocomando vasca esterno.
Single-lever bath mixer.

00	cromo	chrome	€ 83,00
20	cromo-oro	chrome-gold	€ 108,00
08	bianco-cromo	white-chrome	€ 100,00
28	bianco-oro	white-gold	€ 108,00

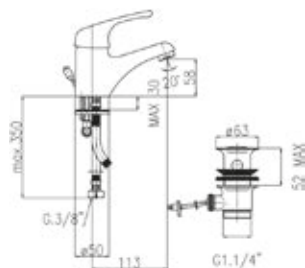

2200

Monocomando lavabo con scarico 1" 1/4.
Single-lever basin mixer with 1 1/4" pop-up waste.

00	cromo	chrome	€ 75,00
20	cromo-oro	chrome-gold	€ 98,00
08	bianco-cromo	white-chrome	€ 90,00
28	bianco-oro	white-gold	€ 98,00

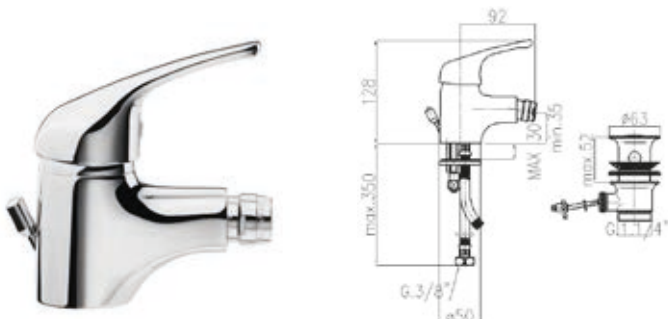

2260

Monocomando bidet con scarico 1" 1/4.
Single-lever bidet mixer with 1" 1/4 pop-up waste.

00	cromo	chrome	€ 77,00
20	cromo-oro	chrome-gold	€ 100,00
08	bianco-cromo	white-chrome	€ 93,00
28	bianco-oro	white-gold	€ 100,00



2300

Monocomando doccia esterno.
Single-lever shower mixer.

00	cromo	chrome	€ 62,00
20	cromo-oro	chrome-gold	€ 81,00
08	bianco-cromo	white-chrome	€ 75,00
28	bianco-oro	white-gold	€ 81,00



2320

monocomando doccia esterno con doccia supporto regolabile e flessibile 150 cm.
Single-lever shower mixer with handshower adjustable bracket and 150 cm flexible hose.

00	cromo	chrome	€ 77,00
20	cromo-oro	chrome-gold	€ 100,00
08	bianco-cromo	white-chrome	€ 93,00
28	bianco-oro	white-gold	€ 100,00

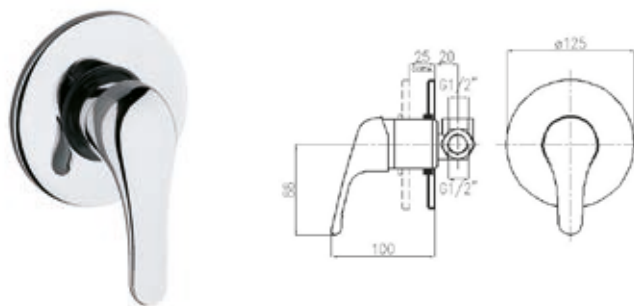

2340

Monocomando incasso doccia con piastra tonda.
Built-in single-lever shower mixer with round plate.

00	cromo	chrome	€ 58,00
20	cromo-oro	chrome-gold	€ 75,00
08	bianco-cromo	white-chrome	€ 70,00
28	bianco-oro	white-gold	€ 75,00

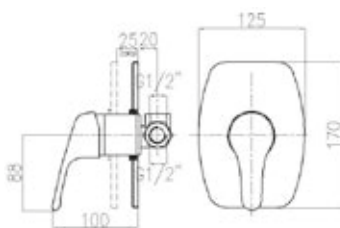

2360

Monocomando incasso doccia con piastra rettangolare.
Built-in single-lever shower mixer with rectangular plate.

00	cromo	chrome	€ 62,00
20	cromo-oro	chrome-gold	€ 81,00
08	bianco-cromo	white-chrome	€ 75,00
28	bianco-oro	white-gold	€ 81,00

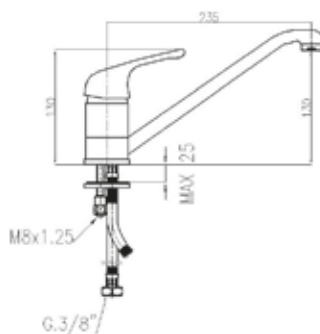

2420

Monocomando lavello con bocca girevole.
Single-lever sink mixer with swivel spout.

00	cromo	chrome	€ 59,00
08	bianco-cromo	white-chrome	€ 71,00

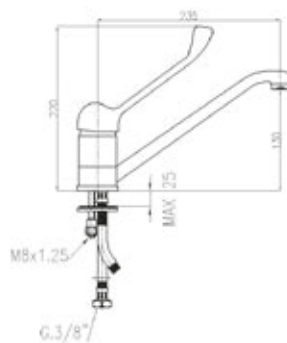

2420-LG

Monocomando lavello con bocca girevole e leva a gomito.
Single-lever sink mixer with swivel spout and elbow lever.

00	cromo	chrome	€ 67,00
----	-------	--------	---------



2460

Monocomando lavello con bocca alta girevole art. 066.
Single lever sink mixer with high swivel spout item 066.

00	cromo	chrome	€ 72,00
08	bianco-cromo	white-chrome	€ 87,00



2465

Monocomandoavello con bocca alta girevole art.067.
Single lever sink mixer with high swivel spout item 067.

00	cromo	chrome	€ 74,00
08	bianco-cromo	white-chrome	€ 89,00



2470

Monocomandoavello con bocca girevole in tubo (art.074).
Single-lever sink mixer with tubular swivel spout (art.074).

00	cromo	chrome	€ 88,00
08	bianco-cromo	white-chrome	€ 106,00

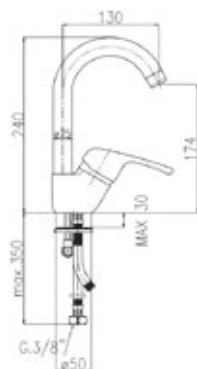

2470-70

Monocomandoavello con bocca girevole art. 070.
Single-lever sink mixer with swivel spout item 070.

00	cromo	chrome	€ 80,00
08	bianco-cromo	white-chrome	€ 96,00

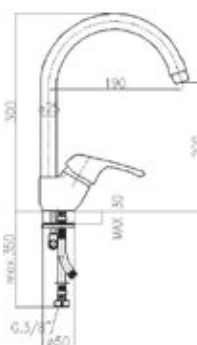

2470-72

Monocomandoavello con bocca alta girevole art. 072.
Single lever sink mixer with high swivel spout item 072.

00	cromo	chrome	€ 84,00
08	bianco-cromo	white-chrome	€ 100,00

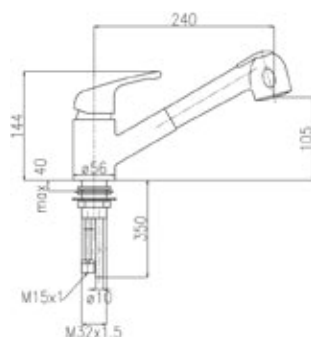

2480

Monocomando lavello con doccia estraibile a due getti.
Single-lever sink mixer with removable 2-jet handshower.

00 cromo [chrome](#) € 96,00

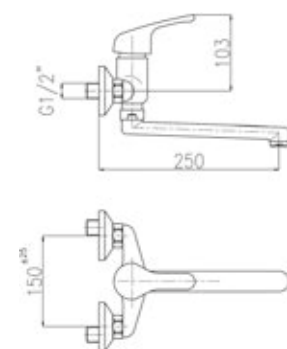

2500

Monocomando lavello esterno con bocca girevole 200 mm.
Single-lever wall sink mixer with 200 mm swivel spout.

00 cromo [chrome](#) € 80,00

08 bianco-cromo [white-chrome](#) € 96,00



2510

Leva in metallo "Top Elite".
"Top Elite" metal lever.

00 cromo [chrome](#) € 8,00

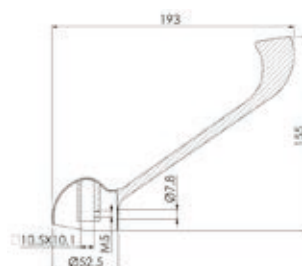

2520

Leva in metallo a gomito "Elite".
"Elite" elbow metal lever.

00 cromo [chrome](#) € 16,00

TECO

COLLEGAMENTI:

Il monocomando per lavabo e bidet sono forniti completi con coppia flessibili acciaio inox art. 703 lunghezza 35 cm attacco G. 3/8" F. A richiesta G. 1/2" F.
La serie TECO è fornita con cartucce Ø 40.

CONNECTIONS:

The single lever basin and bidet mixers are supplied complete with stainless steel flexible hoses item. 703, length 35 cm with 3/8" F GT connection. On request G. 1/2" F.
The TECO series is supplied with Ø 40 cartridges.

 **FARIS**[®]
RUBINETTERIE

 **BUGATTI**
SANITARY-TAPS



**TE 2140**

Monocomando vasca esterno con doccia e flessibile 150cm.
Single-lever bath mixer with handshower and 150 cm flexible hose.

00 cromo chrome € 67,00

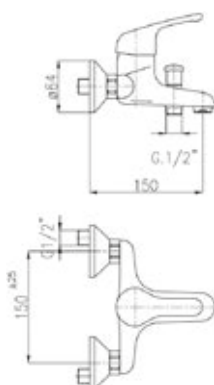
**TE 2180**

Monocomando vasca esterno.
Single-lever bath mixer.

00 cromo chrome € 53,00

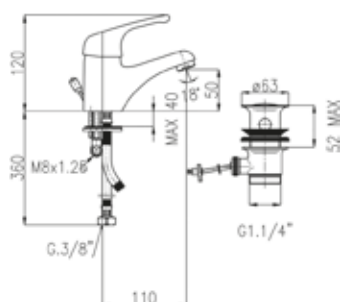
**TE 2200**

Monocomando lavabo con scarico 1"1/4.
Single-lever basin mixer with 1"1/4 pop-up waste.

00 cromo chrome € 52,00

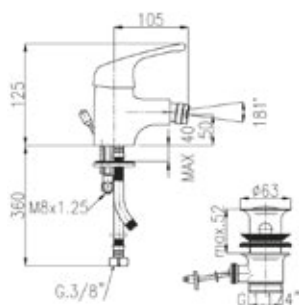
**TE 2260**

Monocomando bidet con scarico da 1"1/4.
Single-lever bidet mixer with 1"1/4 pop-up waste.

00 cromo chrome € 52,00

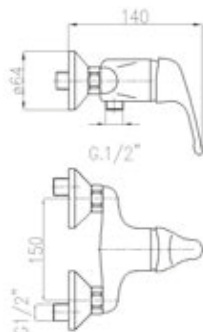

TE 2300

Monocomando doccia esterno.
Single-lever shower mixer.

00 cromo chrome € 50,00

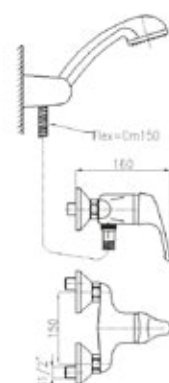

TE 2320

Monocomando doccia esterno con doccia e flessibile 150cm.
Single-lever shower mixer with handshower and 150cm flexible hose.

00 cromo chrome € 64,00

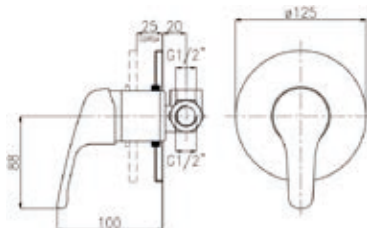

TE 2340

Monocomando incasso doccia con piastra tonda.
Built-in single-lever shower mixer with round plate.

00 cromo chrome € 58,00

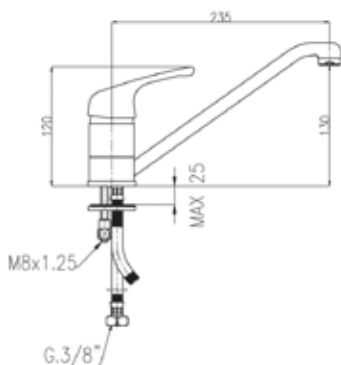

TE 2420

Monocomando lavello con bocca girevole.
Single-lever sink mixer with swivel spout.

00 cromo chrome € 44,00

**TE 2472**

Monocomando lavello con bocca lata girevole in tubo (art.074).

Single-lever sink mixer with high swivel spout item 074.

00 cromo chrome € 64,00

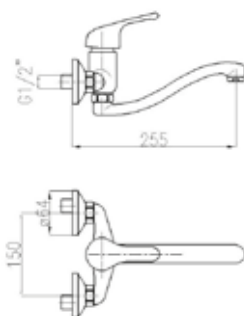
**TE 2504**

Monocomando lavello esterno con bocca girevole.

Single-lever wall sink mixer with swivel spout.

00 cromo chrome € 64,00

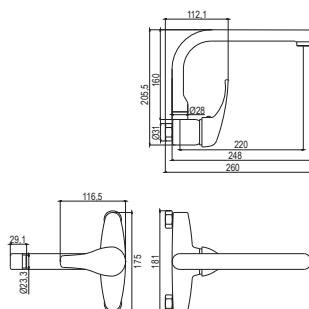
**TE 2508**

Monocomando lavello esterno con bocca girevole fusa.

Single-lever wall sink mixer with cast swivel spout.

00 cromo chrome € 80,00

**TE 2510**

Leva in metallo "Teco".

"Teco" metal lever.

00 cromo chrome € 8,00

LIBERTY

COLLEGAMENTI:

Il monocomando per lavabo e bidet sono forniti completi con coppia flessibili acciaio inox art. 703 lunghezza 35 cm attacco G. 3/8" F. A richiesta G. 1/2" F.

CONNECTIONS:

The single lever basin and bidet mixers are supplied complete with stainless steel flexible hoses item. 703, length 35 cm with 3/8" F GT connection. On request G. 1/2" F.

 **FARIS**[®]
RUBINETTERIE

 **BUGATTI**
SANITARY-TAPS





010

Gruppo vasca incasso con doccia duplex e flessibile cm150.
Built-in bath set with duplex handshower and 150cm flexible hose.

		vitone normale standardized valve	vitone dischi ceramici ceramic disc valve
00	cromo	chrome	€ 253,00 € 260,00
20	cromo-oro	chrome-gold	€ 329,00 € 336,00
08	bianco-cromo	white-chrome	€ 303,00 € 310,00
28	bianco-oro	white-gold	€ 329,00 € 336,00
13	oro	gold	€ 405,00 € 412,00
18	bronzo	bronze	€ 405,00 € 412,00

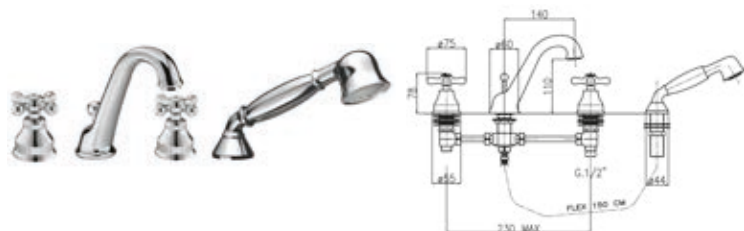

011

Batteria bordo vasca 4 fori con doccia estraibile e flessibile cm150.
4-hole bath-edge set with extractable handshower and 150 cm flexible hose.

		vitone normale standardized valve	vitone dischi ceramici ceramic disc valve
00	cromo	chrome	€ 224,00 € 231,00
20	cromo-oro	chrome-gold	€ 292,00 € 299,00
08	bianco-cromo	white-chrome	€ 268,00 € 275,00
28	bianco-oro	white-gold	€ 292,00 € 299,00
13	oro	gold	€ 359,00 € 366,00
18	bronzo	bronze	€ 359,00 € 366,00



012

Gruppo vasca esterno con doccia e flessibile 120 cm.
Bath mixer with handshower and 120cm flexible hose.

		vitone normale standardized valve	vitone dischi ceramici ceramic disc valve
00	cromo	chrome	€ 174,00 € 181,00
20	cromo-oro	chrome-gold	€ 223,00 € 230,00
08	bianco-cromo	white-chrome	€ 207,00 € 214,00
28	bianco-oro	white-gold	€ 223,00 € 230,00
13	oro	gold	€ 272,00 € 279,00
18	bronzo	bronze	€ 272,00 € 279,00



012-CP

Gruppo vasca esterno con doccia e flessibile 120 cm.
completo di colonne fissaggio a pavimento.
Bath mixer with duplex handshower and 120 cm flexible hose complete with pillars for fixing the floor.

		vitone normale standardized valve	vitone dischi ceramici ceramic disc valve
00	cromo	chrome	€ 780,00 € 787,00
20	cromo-oro	chrome-gold	€1.014,00 €1.021,00
08	bianco-cromo	white-chrome	€ 936,00 € 943,00
28	bianco-oro	white-gold	€1.014,00 €1.021,00
13	oro	gold	€1.248,00 €1.255,00
18	bronzo	bronze	€1.248,00 €1.255,00

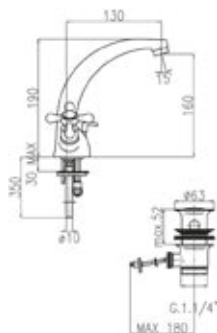

023

Gruppo monoforo lavabo con bocca girevole fusa e scarico 1"1/4.
Single-hole basin mixer with cast swivel spout and 1"1/4 pop-up waste.

		vitone normale standardized valve	vitone dischi ceramici ceramic disc valve
00	cromo	chrome	€ 110,00 € 117,00
20	cromo-oro	chrome-gold	€ 143,00 € 150,00
08	bianco-cromo	white-chrome	€ 132,00 € 139,00
28	bianco-oro	white-gold	€ 143,00 € 150,00
13	oro	gold	€ 176,00 € 183,00
18	bronzo	bronze	€ 176,00 € 183,00

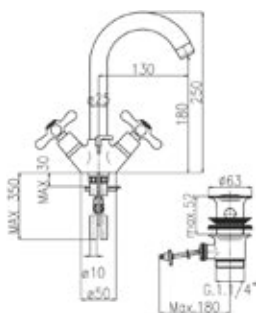

023-70

Gruppo monoforo lavabo con bocca girevole art.070 e scarico 1"1/4.
Single hole basin mixer with swivel spout item 070 and 1"1/4 pop-up waste.

		vitone normale standardized valve	vitone dischi ceramici ceramic disc valve
00	cromo	chrome	€ 97,00 € 104,00
20	cromo-oro	chrome-gold	€ 126,00 € 133,00
08	bianco-cromo	white-chrome	€ 116,00 € 123,00
28	bianco-oro	white-gold	€ 126,00 € 133,00
13	oro	gold	€ 155,00 € 162,00
18	bronzo	bronze	€ 155,00 € 162,00

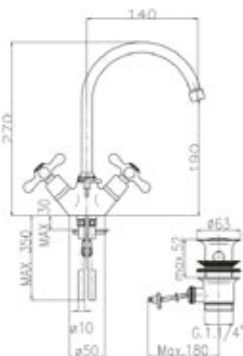

023-P

Gruppo monoforo lavabo con bocca girevole Ø18mm e scarico 1"1/4.
Single-hole basin mixer with Ø18mm swivel spout and 1"1/4 pop-up waste.

		vitone normale standardized valve	vitone dischi ceramici ceramic disc valve
00	cromo	chrome	€ 88,00 € 95,00
20	cromo-oro	chrome-gold	€ 115,00 € 122,00
08	bianco-cromo	white-chrome	€ 106,00 € 113,00
28	bianco-oro	white-gold	€ 115,00 € 122,00
13	oro	gold	€ 141,00 € 148,00
18	bronzo	bronze	€ 141,00 € 148,00

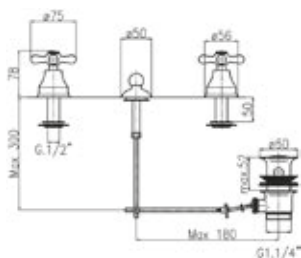

024

Combinazione bidet con scarico 1"1/4.
Bidet set with 1"1/4 pop-up waste.

		vitone normale standardized valve	vitone dischi ceramici ceramic disc valve
00	cromo	chrome	€ 86,00 € 93,00
20	cromo-oro	chrome-gold	€ 112,00 € 119,00
08	bianco-cromo	white-chrome	€ 103,00 € 110,00
28	bianco-oro	white-gold	€ 112,00 € 119,00
13	oro	gold	€ 138,00 € 145,00
18	bronzo	bronze	€ 138,00 € 145,00



027-A-DX

Gruppo doccia esterno con doccia duplex e flessibile 150 cm.
Shower mixer with duplex handshower and 150 cm flexible hose.

			vitone normale standarzed valve	vitone dischi ceramici ceramic disc valve
00	cromo	chrome	€ 116,00	€ 123,00
20	cromo-oro	chrome-gold	€ 151,00	€ 158,00
08	bianco-cromo	white-chrome	€ 139,00	€ 146,00
28	bianco-oro	white-gold	€ 151,00	€ 158,00
13	oro	gold	€ 186,00	€ 193,00
18	bronzo	bronze	€ 186,00	€ 193,00

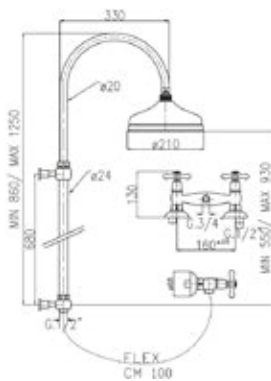

027-A + AC240

Gruppo doccia esterno con colonna doccia regolabile, soffione Ø200 mm e flessibile 120cm.

Shower mixer with adjustable riser pipe Ø 200 mm shower head and 120 cm flexible hose.

			vitone normale standarzed valve	vitone dischi ceramici ceramic disc valve
00	cromo	chrome	€ 470,00	€ 477,00
20	cromo-oro	chrome-gold	€ 612,00	€ 619,00
08	bianco-cromo	white-chrome	€ 564,00	€ 571,00
28	bianco-oro	white-gold	€ 612,00	€ 619,00
13	oro	gold	€ 752,00	€ 759,00
18	bronzo	bronze	€ 752,00	€ 759,00

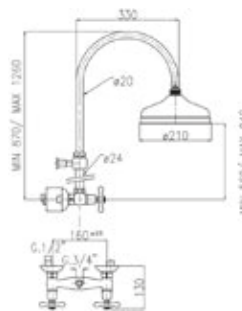

027 + AC260

Gruppo doccia esterno con colonna doccia regolabile, soffione Ø200mm.
Shower mixer with adjustable riser pipe and Ø 200 mm shower head.

			vitone normale standarzed valve	vitone dischi ceramici ceramic disc valve
00	cromo	chrome	€ 420,00	€ 427,00
20	cromo-oro	chrome-gold	€ 546,00	€ 553,00
08	bianco-cromo	white-chrome	€ 504,00	€ 511,00
28	bianco-oro	white-gold	€ 546,00	€ 553,00
13	oro	gold	€ 672,00	€ 679,00
18	bronzo	bronze	€ 672,00	€ 679,00

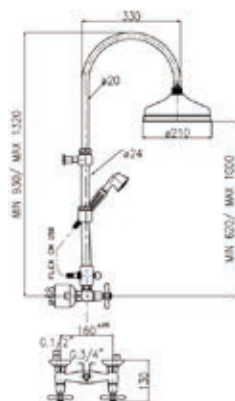

027+AC270

Gruppo doccia esterno con colonna doccia regolabile, soffione Ø 200 mm, doccia a mano flessibile cm150 e deviatore a 3 vie.

Shower mixer with adjustable riser pipe Ø v200 mm shower head, handshower, 150 cm flexible hose 3-way diverter.

			vitone normale standarzed valve	vitone dischi ceramici ceramic disc valve
00	cromo	chrome	€ 520,00	€ 527,00
20	cromo-oro	chrome-gold	€ 676,00	€ 683,00
08	bianco-cromo	white-chrome	€ 624,00	€ 631,00
28	bianco-oro	white-gold	€ 676,00	€ 683,00
13	oro	gold	€ 832,00	€ 839,00
18	bronzo	bronze	€ 832,00	€ 839,00

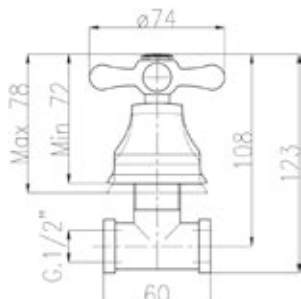

028

Coppia rubinetti da incasso con sede estraibile.
Couple of built-in taps with extractable seat.

			vitone normale standard valve	vitone dischi ceramici ceramic disc valve
00	cromo	chrome	€ 66,00	€ 72,00
20	cromo-oro	chrome-gold	€ 86,00	€ 93,00
08	bianco-cromo	white-chrome	€ 79,00	€ 86,00
28	bianco-oro	white-gold	€ 86,00	€ 93,00
13	oro	gold	€ 105,00	€ 112,00
18	bronzo	bronze	€ 105,00	€ 112,00

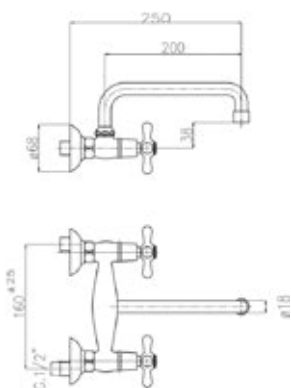

029

Gruppo lavello esterno con bocca girevole a "U" Ø 18 mm.
Wall sink mixer with Ø 18 "U" swivel spout.

			vitone normale standard valve	vitone dischi ceramici ceramic disc valve
00	cromo	chrome	€ 76,00	€ 83,00
20	cromo-oro	chrome-gold	€ 99,00	€ 106,00
08	bianco-cromo	white-chrome	€ 91,00	€ 98,00
28	bianco-oro	white-gold	€ 99,00	€ 106,00
13	oro	gold	€ 122,00	€ 129,00
18	bronzo	bronze	€ 122,00	€ 129,00

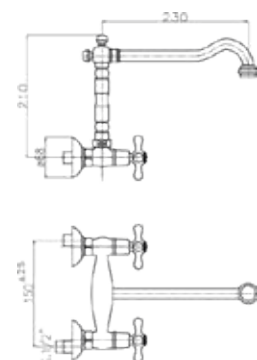

029-B

Gruppo lavello esterno con bocca girevole antica art. B80.
Wall sink mixer with swivel spout B80.

			vitone normale standard valve	vitone dischi ceramici ceramic disc valve
00	cromo	chrome	€ 156,00	€ 163,00
20	cromo-oro	chrome-gold	€ 203,00	€ 210,00
08	bianco-cromo	white-chrome	€ 187,00	€ 194,00
28	bianco-oro	white-gold	€ 203,00	€ 210,00
13	oro	gold	€ 234,00	€ 241,00
18	bronzo	bronze	€ 234,00	€ 241,00

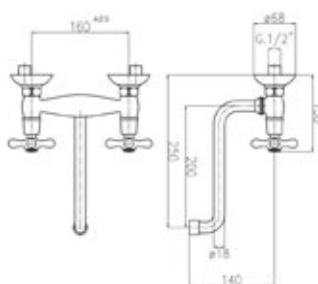

030

Gruppo lavello esterno con bocca girevole a "S" Ø 18 mm.
Wall sink mixer with Ø 18 mm "S" swivel spout.

			vitone normale standard valve	vitone dischi ceramici ceramic disc valve
00	cromo	chrome	€ 76,00	€ 83,00
20	cromo-oro	chrome-gold	€ 99,00	€ 106,00
08	bianco-cromo	white-chrome	€ 91,00	€ 98,00
28	bianco-oro	white-gold	€ 99,00	€ 106,00
13	oro	gold	€ 122,00	€ 129,00
18	bronzo	bronze	€ 122,00	€ 129,00

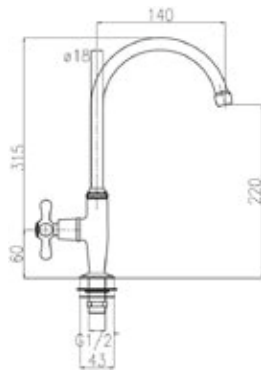

031

Rubinetto a colonna con bocca girevole Ø 18 mm.
Pillar tap with Ø 18 mm swivel spout.

		vitone normale standardized valve	vitone dischi ceramici ceramic disc valve
00	cromo	chrome	€ 41,00 € 45,00
20	cromo-oro	chrome-gold	€ 53,00 € 57,00
08	bianco-cromo	white-chrome	€ 50,00 € 53,00
28	bianco-oro	white-gold	€ 53,00 € 57,00
13	oro	gold	€ 66,00 € 70,00
18	bronzo	bronze	€ 66,00 € 70,00

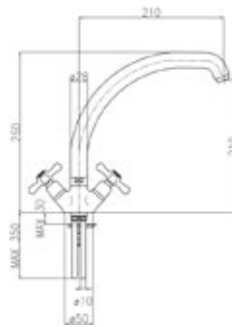

032

Gruppo monoforo lavello con bocca girevole in tubo (074).
Single hole sink mixer with tubular swivel spout (art.074).

		vitone normale standardized valve	vitone dischi ceramici ceramic disc valve
00	cromo	chrome	€ 90,00 € 97,00
20	cromo-oro	chrome-gold	€ 117,00 € 124,00
08	bianco-cromo	white-chrome	€ 108,00 € 115,00
28	bianco-oro	white-gold	€ 117,00 € 124,00
13	oro	gold	€ 144,00 € 151,00
18	bronzo	bronze	€ 144,00 € 151,00

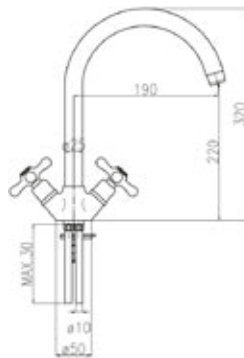

032-72

Gruppo monoforo lavello con bocca girevole art.072.
Single-hole sink mixer with high swivel spout item 072.

		vitone normale standardized valve	vitone dischi ceramici ceramic disc valve
00	cromo	chrome	€ 94,00 € 100,00
20	cromo-oro	chrome-gold	€ 122,00 € 127,00
08	bianco-cromo	white-chrome	€ 112,00 € 119,00
28	bianco-oro	white-gold	€ 122,00 € 127,00
13	oro	gold	€ 150,00 € 157,00
18	bronzo	bronze	€ 150,00 € 157,00

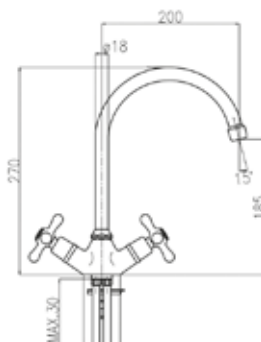

033

Gruppo monoforo lavello con bocca girevole Ø 18 mm.
Single-hole sink mixer with Ø 18 mm swivel spout.

		vitone normale standardized valve	vitone dischi ceramici ceramic disc valve
00	cromo	chrome	€ 64,00 € 71,00
20	cromo-oro	chrome-gold	€ 83,00 € 90,00
08	bianco-cromo	white-chrome	€ 77,00 € 84,00
28	bianco-oro	white-gold	€ 83,00 € 90,00
13	oro	gold	€ 103,00 € 110,00
18	bronzo	bronze	€ 103,00 € 110,00

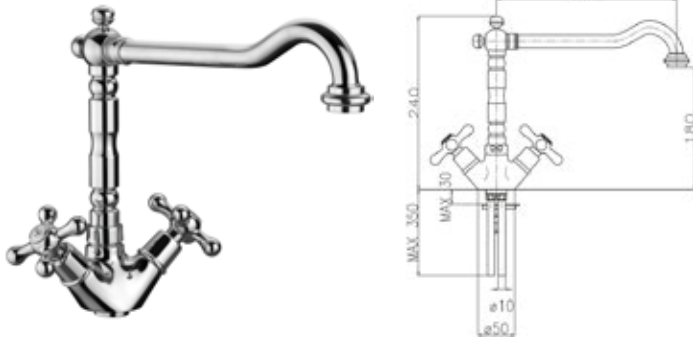

033-B

Gruppo monoforo livello con bocca girevole antica art. B80.
Single-hole sink mixer with Retro' swivel spout.

		vitone normale standardized valve	vitone dischi ceramici ceramic disc valve
00	cromo	chrome	€ 156,00 € 163,00
20	cromo-oro	chrome-gold	€ 203,00 € 210,00
08	bianco-cromo	white-chrome	€ 187,00 € 194,00
28	bianco-oro	white-gold	€ 203,00 € 210,00
13	oro	gold	€ 250,00 € 256,00
18	bronzo	bronze	€ 250,00 € 256,00

034

Rubinello livello con bocca girevole a "S" Ø 18 mm.
Sink tap with Ø 18 mm "S" swivel spout.

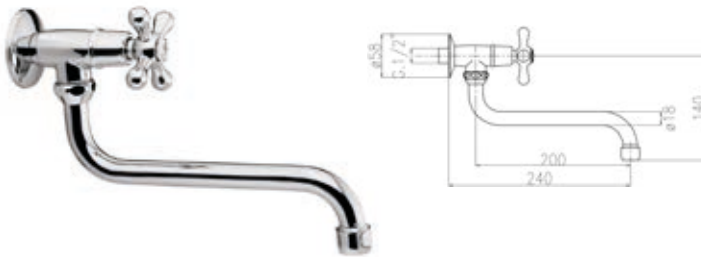

		vitone normale standardized valve	vitone dischi ceramici ceramic disc valve
00	cromo	chrome	€ 36,00 € 39,00
20	cromo-oro	chrome-gold	€ 46,00 € 49,00
08	bianco-cromo	white-chrome	€ 43,00 € 46,00
28	bianco-oro	white-gold	€ 46,00 € 49,00
13	oro	gold	€ 56,00 € 60,00
18	bronzo	bronze	€ 56,00 € 60,00

034-A

Rubinetto livello con bocca girevole a "U" Ø 18 mm.
Sink tap with Ø 18 mm "U" swivel spout.



		vitone normale standardized valve	vitone dischi ceramici ceramic disc valve
00	cromo	chrome	€ 36,00 € 39,00
20	cromo-oro	chrome-gold	€ 46,00 € 49,00
08	bianco-cromo	white-chrome	€ 43,00 € 46,00
28	bianco-oro	white-gold	€ 46,00 € 49,00
13	oro	gold	€ 56,00 € 60,00
18	bronzo	bronze	€ 56,00 € 60,00

038

Rubinetto prolungato 10 cm.
10 cm. prolonged tap.

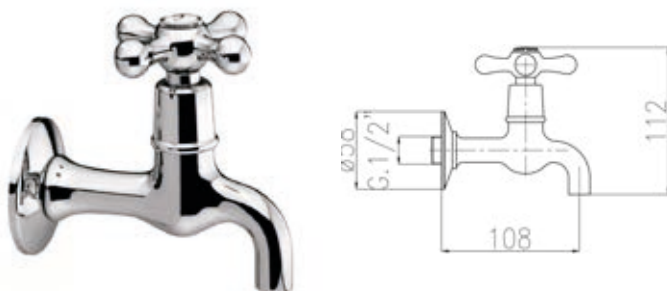

		vitone normale standardized valve	vitone dischi ceramici ceramic disc valve
00	cromo	chrome	€ 24,00 € 27,00
20	cromo-oro	chrome-gold	€ 31,00 € 34,00
08	bianco-cromo	white-chrome	€ 29,00 € 32,00
28	bianco-oro	white-gold	€ 31,00 € 34,00
13	oro	gold	€ 38,00 € 41,00
18	bronzo	bronze	€ 38,00 € 41,00

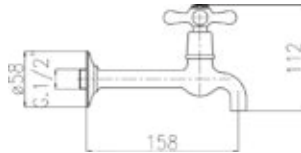

038-A

Rubinetto prolungato cm.15
15 cm. prolonged tap.

		vitone normale standardized valve	vitone dischi ceramici ceramic disc valve
00	cromo	chrome	€ 29,00 € 33,00
20	cromo-oro	chrome-gold	€ 38,00 € 42,00
08	bianco-cromo	white-chrome	€ 35,00 € 38,00
28	bianco-oro	white-gold	€ 38,00 € 42,00
13	oro	gold	€ 46,00 € 50,00
18	bronzo	bronze	€ 46,00 € 50,00

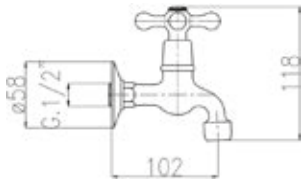

039

Rubinetto 10 cm. Con aeratore.
10 cm. tap with aerator.

		vitone normale standardized valve	vitone dischi ceramici ceramic disc valve
00	cromo	chrome	€ 25,00 € 29,00
20	cromo-oro	chrome-gold	€ 33,00 € 36,00
08	bianco-cromo	white-chrome	€ 30,00 € 34,00
28	bianco-oro	white-gold	€ 33,00 € 36,00
13	oro	gold	€ 40,00 € 44,00
18	bronzo	bronze	€ 40,00 € 44,00

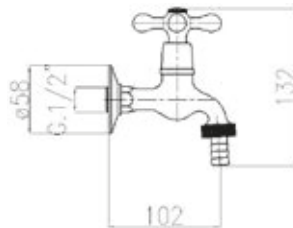

039-A

Rubinetto 10 cm. con portagomma.
10 cm. tap with hose holder.

		vitone normale standardized valve	vitone dischi ceramici ceramic disc valve
00	cromo	chrome	€ 25,00 € 29,00
20	cromo-oro	chrome-gold	€ 33,00 € 36,00
08	bianco-cromo	white-chrome	€ 30,00 € 34,00
28	bianco-oro	white-gold	€ 33,00 € 36,00
13	oro	gold	€ 40,00 € 44,00
18	bronzo	bronze	€ 40,00 € 44,00

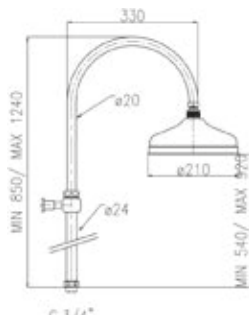

AC260

Colonna doccia regolabile con soffione Ø 200 mm attacco 3/4".
Adjustable shower pipe with Ø 200 mm shower head, 3/4" connection.

00	cromo	chrome	€ 350,00
20	cromo-oro	chrome-gold	€ 450,00
08	bianco-cromo	white-chrome	€ 420,00
28	bianco-oro	white-gold	€ 450,00
13	oro	gold	€ 560,00
18	bronzo	bronze	€ 560,00

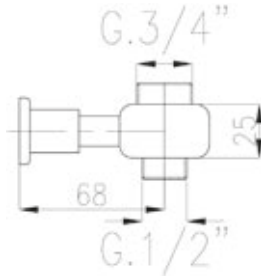

AC242

Supporto colonna doccia con attacco 3/4" M.x1/2" M.
Riser pipe bracket with 3/4" M.x1/2" M connection.

00	cromo	chrome	€ 40,00
20	cromo-oro	chrome-gold	€ 50,00
08	bianco-cromo	white-chrome	€ 45,00
28	bianco-oro	white-gold	€ 50,00
13	oro	gold	€ 60,00
18	bronzo	bronze	€ 60,00

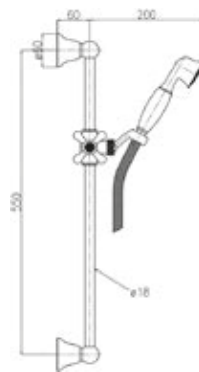

046

Saliscendi 60 cm completo di doccia "Liberty" e flessibile cm. 150.

60 cm slide rail with "Liberty" handshower and 150 cm flexible hose.

00	cromo	chrome	€ 150,00
20	cromo-oro	chrome-gold	€ 182,00
08	bianco-cromo	white-chrome	€ 168,00
28	bianco-oro	white-gold	€ 182,00
13	oro	gold	€ 225,00
18	bronzo	bronze	€ 225,00

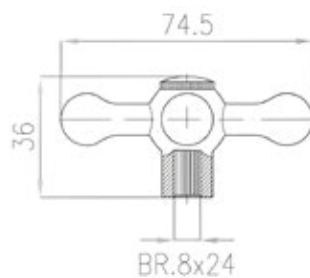

M050

Maniglia "Liberty" completa di indicatore attacco Ø8x24.
"Liberty" handle with indicator Ø8x24.

00	cromo	chrome	€ 8,00
20	cromo-oro	chrome-gold	€ 10,00
08	bianco-cromo	white-chrome	€ 9,00
28	bianco-oro	white-gold	€ 10,00
13	oro	gold	€ 13,00
18	bronzo	bronze	€ 13,00



M052

Coprivitone "Liberty" 24x1.
24x1 "Liberty" valve cover.

00	cromo	chrome	€ 3,00
13	oro	gold	€ 6,00
18	bronzo	bronze	€ 6,00

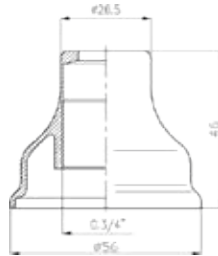

010/04

Cappuccio per maniglia "Liberty".
Cover for "Liberty" handle.

00	cromo	chrome	€ 11,00
08	bianco cromo	white-chrome	€ 13,00
13	oro	gold	€ 17,00
18	bronzo	bronze	€ 17,00

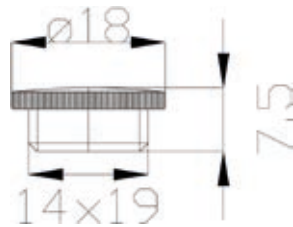

010/13.C

Placchetta per maniglia "Liberty" modello acqua calda e fredda.
Indicator for "Liberty" handle hot-cold water model.

00	cromo	chrome	€ 3,00
13	oro	gold	€ 6,00
18	bronzo	bronze	€ 6,00

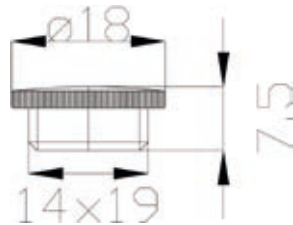

010/13.D

Placchetta deviatore per modelli "Liberty".
Diverter indicator for "Liberty" models.

00	cromo	chrome	€ 3,00
13	oro	gold	€ 6,00
18	bronzo	bronze	€ 6,00

CUCINA

 **FARIS**[®]
RUBINETTERIE

 **BUGATTI**
SANITARY-TAPS

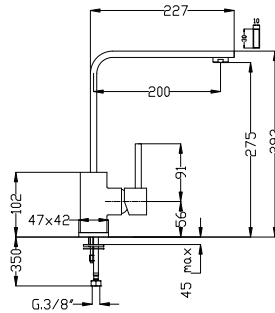

**BS720**

Monocomando livello con bocca girevole.
Single lever sink mixer with swivel spout.

00 cromo chrome € 195,00

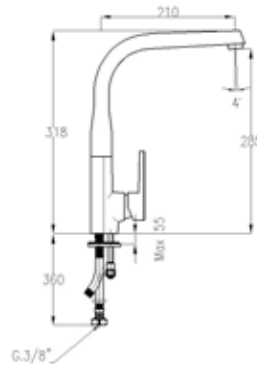
**BS75**

Monocomando livello con bocca girevole fusa.
Single lever sink mixer with swivel spout.

00 cromo chrome € 185,00

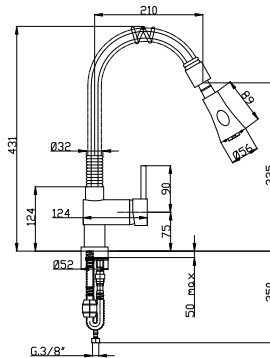
**BS730**

Monocomando livello con doccetta estraibile.
Single lever sink mixer with extractable shower.

00 cromo chrome € 258,00

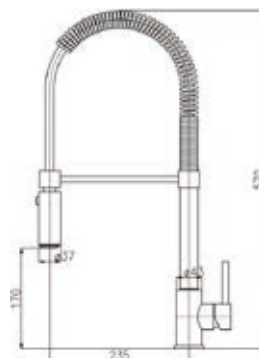
**BS820**

Monocomando livello con doccetta orientabile a 2 getti.
Single lever sink mixer with adjustable two-jet handshower.

00 cromo chrome € 280,00

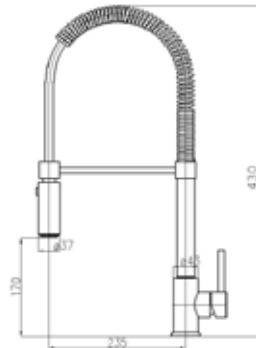

BS820/B

Monocomandoavello con doccetta orientabile a due getti, altezza 43 cm.

Single lever sink mixer with swivel spout and adjustable two jet shower.

00 cromo chrome € 280,00

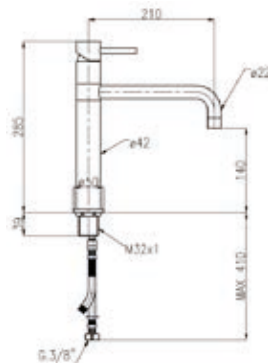

BS600

Monocomandoavello con bocca girevole.

Single lever sink mixer swivel spout.

00 cromo chrome € 90,00

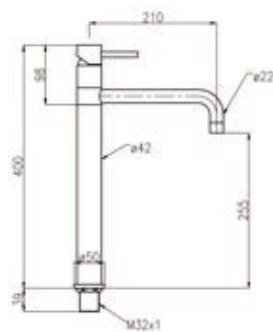

BS650

Monocomandoavello alto con bocca girevole.

Higt single lever sink mixer with swivel spout

00 cromo chrome € 150,00

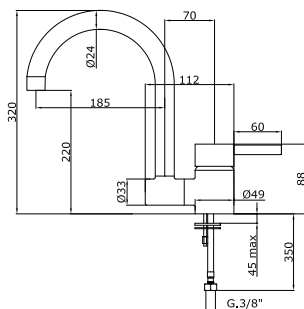

BS805

Monocomandoavello sottofinestra con bocca girevole abbattibile.

Below window single lever sink mixer with folding spout.

00 cromo chrome € 135,00

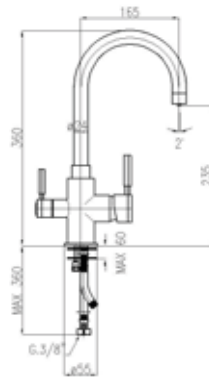
**BS810**

Monocomando livello doppia funzione, acqua calda/fredda ed entrata acqua fredda diretta.

Duble function single-lever sink mixer, hot/cold water and direct cold water inject.

00 cromo chrome € 180,00

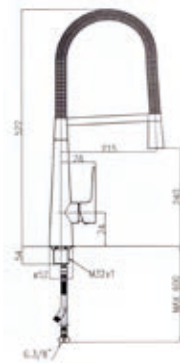
**BS506**

Monocomando livello con doccetta orientabile.

Single lever sink mixer with adjustable shower.

00 cromo chrome € 265,00

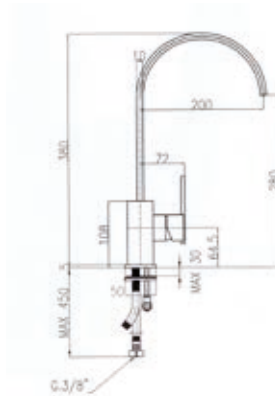
**BS505**

Monocomando livello con bocca girevole.

Single lever sink mixer with swivel spout.

00 cromo chrome € 180,00

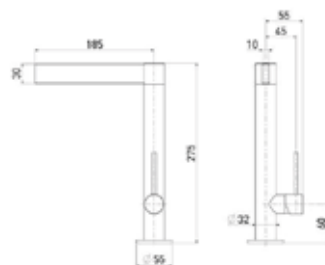
**BS113**

Monocomando livello con bocca ultrapiatta.

Single lever sink mixer with ultra-flat spout.

00 cromo chrome € 320,00

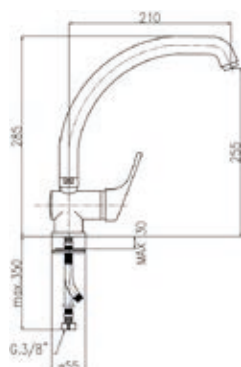

BS37

Monocomando livello con bocca alta girevole.
Single lever sink mixer with high swivel spout.

00 cromo chrome € 127,00

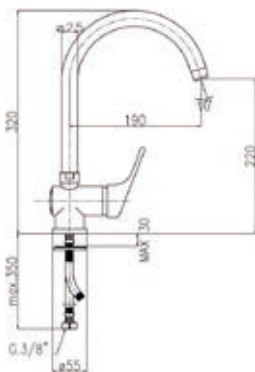

BS38-72

Monocomando livello con bocca alta girevole art.072.
Single lever sink mixer with high swivel spout art.072

00 cromo chrome € 130,00

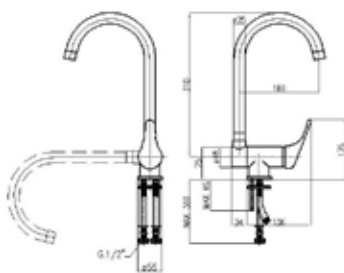

BS39-D

Monocomando livello sottofinestra con canna pieghevole.
Single-lever sink mixer with folding spout.

00 cromo chrome € 210,00

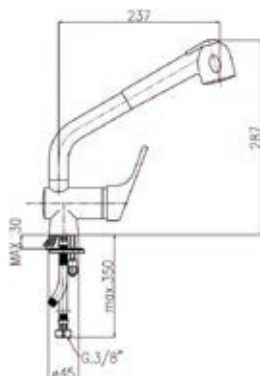

BS36

Monocomando livello con doccia estraibile a due getti.
Single lever sink mixer with two-jet pull-out shower.

00 cromo chrome € 140,00

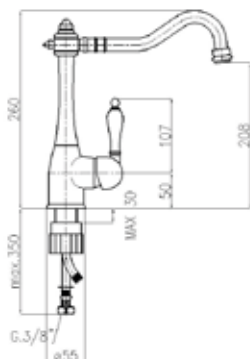
**BS85**

Monocomandoavello con bocca girevole.
Single lever sink mixer with swivel spout.

00	cromo	chrome	€ 98,00
18	bronzo	bronze	€ 157,00

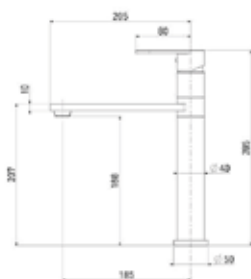
**BS128**

Monocomandoavello con bocca piatta.
Single lever sink mixer with flat spout.

00	cromo	chrome	€ 210,00
----	-------	--------	----------

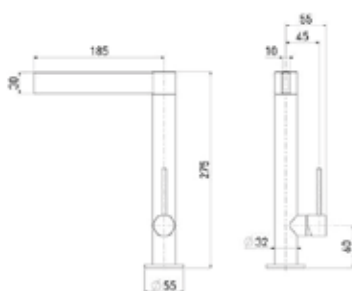
**BS602**

Monocomandoavello con bocca girevole.
Single lever sink mixer with swivel spout.

00	cromo	chrome	€ 240,00
----	-------	--------	----------

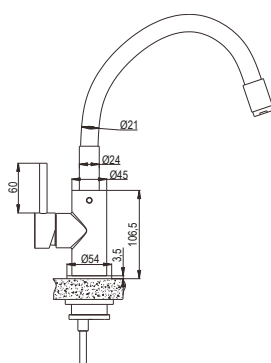
**BS570**

Monocomandoavello con bocca alta e flessibile con aeratore a 2 funzioni.

Single lever kitchen faucet, high and flexible spout with two functions aerator.

cromo-bianco	white-chrome	€ 115,00
cromo-nero	black-chrome	€ 115,00

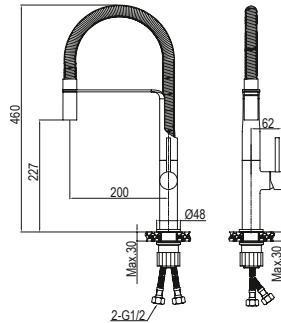

BS800

Miscelatoreavello con bocca girevole orientabile.
Single lever sink mixer, with spring spout.

00 cromo chrome € 252,00

MISCELATORI IN ACCIAIO INOX

Stainless steel mixers

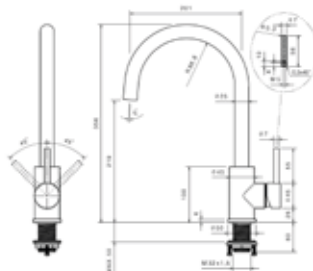

BS900

Miscelatoreavello in acciaio inox AISI 304 con bocca girevole.
Sink mixer, in AISI 304 stainless steel, with swivel spout.

€ 240,00

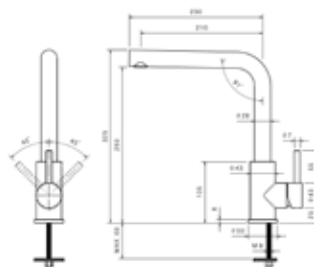

BS901

Miscelatoreavello in acciaio inox AISI 304 con bocca girevole.
Sink mixer, in AISI 304 stainless steel, with swivel spout.

€ 320,00

QUICK

 **FARIS**[®]
RUBINETTERIE

 **BUGATTI**
SANITARY-TAPS

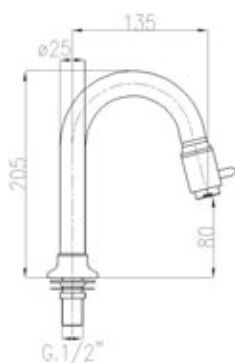

**2202-10**

Bocca lavabo Ø 25 mm fissa con apertura 1/4 di giro a dischi ceramici 1/2".

1/2" fixed basin spout Ø 25 mm with 1/4 turn ceramic-disc opening.

00 cromo chrome € 61,00

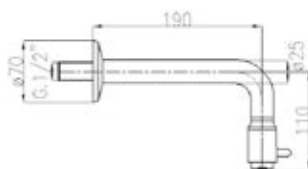
**2432-20**

Bocca a parete Ø 25 mm con apertura 1/4 di giro a dischi ceramici 1/2".

1/2" wall spout Ø 25 mm with 1/4 turn ceramic-disc opening.

00 cromo chrome € 55,00

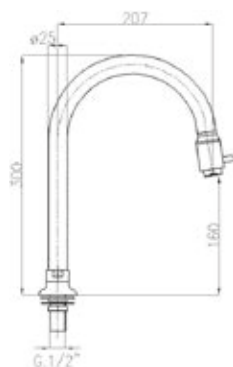
**2422-30**

Bocca lavello Ø 25 mm girevole con apertura 1/4 di giro a dischi ceramici 1/2".

1/2" sink projection swivel spout Ø 25 mm with 1/4 turn ceramic-disc opening.

00 cromo chrome € 71,00

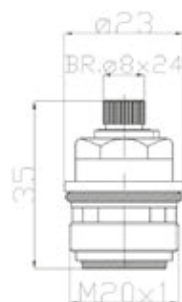
**2059**

Valvola 1/4 di giro a dischi ceramici.

1/4 Turn ceramic-disc valve.

00 cromo chrome € 6,00

PARRUCCHIERE

 **FARIS**[®]
RUBINETTERIE

 **BUGATTI**
SANITARY-TAPS

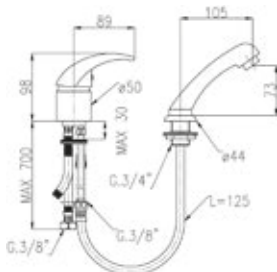

**MP470-10**

Monocomando parrucchiere "Style" con cartuccia Ø 40 mm. flessibili di alimentazione in acciaio inox 70 cm flessibile in PVC grigio metallizzato 125 cm e doccia cromata.

Hairdresser single lever with Ø 40 mm cartridge, 70 cm. stainless steel connection hoses. Metallic grey PVC flexible hose 125 cm. and chromed shower.

00 cromo chrome € 72,00

idem con doccia nera ditto with black handshower € 71,00

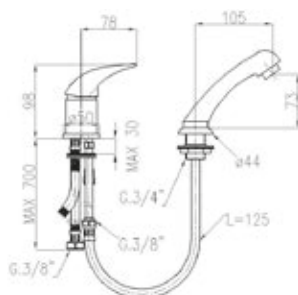
**MP480-10**

Monocomando parrucchiere "Rosy" con cartuccia Ø 35 mm. flessibili di alimentazione in acciaio inox 70 cm. Flessibile in PVC grigio metallizzato 125 cm e doccia cromata.

Hairdresser single lever with Ø 35 cartridge, 70 cm stainless steel connection hoses. Metallic grey PVC flexible hose 125cm. and chromed shower.

00 cromo chrome € 64,00

idem con doccia nera ditto with black handshower € 63,00

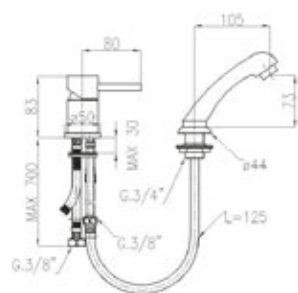
**MP490-10**

Monocomando parrucchiere "minimalista" con cartuccia Ø 35 mm flessibili di alimentazione in acciaio inox 70 cm. Flessibile in PVC grigio metallizzato 125 cm. e doccia cromata.

Hairdresser single lever with Ø35 mm cartridge, 70 cm. stainless steel connection hoses. Metallic grey PVC flexible hose 125 cm. and chromed shower.

00 cromo chrome € 70,00

idem con doccia nera ditto with black handshower € 69,00

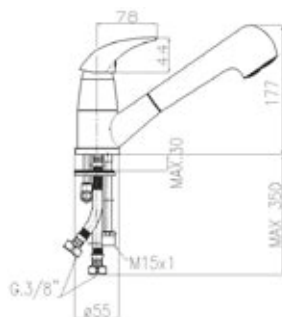
**MP1077**

Monocomando parrucchiere con doccia estraibile a due getti e flessibile nylon rinforzato grigio 150 cm.

Hairdresser single lever mixer with extractable 2-jet handshower and 150 cm grey reinforced nylon flexible hose.

00 cromo chrome € 82,00

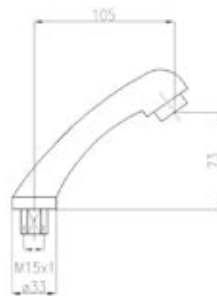

D.5.10

Doccia parrucchiere cromata con raccordo 15x1F.
Chromed hairdresser handshower with union 15x1F.

00 cromo chrome € 18,00

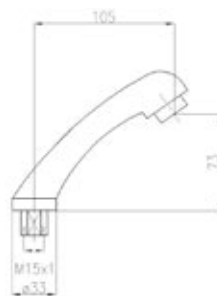

D.5.20

Doccia parrucchiere nera con raccordo 15x1F.
Black hairdresser handshower with union 15x1F.

00 nera black € 17,00

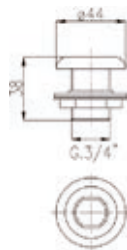

D.5.40

Supporto in ABS cromato per doccia parrucchiere.
ABS chromed support for hairdresser shower.

00 cromo chrome € 10,00



703

Coppia tubi flessibili in acciaio inox DN6
M.10X1X3/8\"/>

00 cromo chrome € 12,00



F560

Flessibile in PVC grigio metallizzato Ø 12 mm 15x1M
con raccordo girevole 3/8\"/>

00 cromo chrome € 12,00

ACCESSORI

 **FARIS**[®]
RUBINETTERIE

 **BUGATTI**
SANITARY-TAPS



ACCESSORIES

Flessibili
Flexible hose



708

Flessibile doccia bi-flex 1/2"x1/2" F.F.
Bi-flex flexible hose 1/2"x1/2" F.F.

cm. 100	08	bianco-cromo	white-chrome	€	4,30
cm. 120	08	bianco-cromo	white-chrome	€	4,50
cm. 150	08	bianco-cromo	white-chrome	€	4,95
cm. 200	08	bianco-cromo	white-chrome	€	5,80



708-1

Flessibile doccia bi-flex 1/2"x1/2" F.F. conico.
Bi-flex flexible hose 1/2"x1/2" F.F. with conical nut.

cm. 120	08	bianco-cromo	white-chrome	€	4,95
cm. 150	08	bianco-cromo	white-chrome	€	5,40
cm. 200	08	bianco-cromo	white-chrome	€	6,30



709

Flessibile doccia cromato 1/2"x1/2" F.F.
Chrome plated flexible hose 1/2"x1/2" F.F.

cm. 100	00	cromo	chrome	€	4,00
cm. 120	00	cromo	chrome	€	4,40
cm. 150	00	cromo	chrome	€	5,00
cm. 200	00	cromo	chrome	€	7,50



710

Flessibile doccia cromato 1/2"x1/2" F.F. conico.
Chrome plated flexible hose 1/2"x1/2" F.F. with conical nut.

cm. 120	00	cromo	chrome	€	5,00
cm. 150	00	cromo	chrome	€	5,50
cm. 200	00	cromo	chrome	€	7,60



044

Flessibile doccia doppia aggraffatura 1/2"x1/2" F.F. conico.
Double interlock flexible hose 1/2"x1/2" F.F. with conical nut.

cm.	120	00	cromo	chrome	€	13,20
cm.	150	00	cromo	chrome	€	14,00
cm.	120	13	oro	gold	€	30,00
cm.	150	13	oro	gold	€	35,00
cm.	120	18	bronzo	bronze	€	27,00
cm.	150	18	bronzo	bronze	€	28,00



045

Flessibile doppia aggraffatura 3/8"x1/2" F.F. conico.
Double interlock flexible hose 3/8"x1/2" F.F. with conic nut.

cm.	120	00	cromo	chrome	€	14,00
cm.	150	00	cromo	chrome	€	18,50
cm.	120	13	oro	gold	€	30,00
cm.	150	13	oro	gold	€	35,00
cm.	120	18	bronzo	bronze	€	28,00
cm.	150	18	bronzo	bronze	€	33,00



0167

Flessibile cromalux metallizzato 1/2"x1/2" F.F. conico girevole.
Cromalux bright plastic flexible hose silver color 1/2"x1/2" F.F. conical swivel nut.

cm.	150	00	cromo	chrome	€	20,50
-----	-----	----	-------	--------	---	-------



0168

Flessibile doccia a doppia aggraffatura con raccordo girevole
15x1 M. x 1/2" F. conico x docce estraibili.
Double interlock flexible hose with 15x1Mx1/2"F. conical swivel nut for extractable showers.

cm.	150	00	cromo	chrome	€	13,80
-----	-----	----	-------	--------	---	-------



0169

Flessibile nylon rinforzato con raccordo girevole 15x1Mx1/2" f.
conico conico per docce estraibili.
Nylon reinforced flexible hose with 15x1Mx1/2"F. conical swivel nut for extractable shower.

cm.	150	00	cromo	chrome	€	9,80
-----	-----	----	-------	--------	---	------



Docce
Handshower

AC745

Doccia in ottone cromato "Quadric" monogetto attacco 1/2".

1/2" brass "Quadric" one-jet handshower.

00 cromo [chrome](#) € 35,00



9900

Doccia "Futurist" monogetto attacco 1/2".

1/2" Futurist" one-jet handshower.

00 cromo [chrome](#) € 8,00

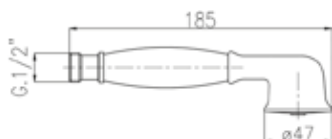

040

Doccia "Liberty" monogetto con impugnatura in metallo cromato attacco da 1/2".

1/2" "Liberty" one-jet handshower with metal chromed plated grip.

00	cromo	chrome	€ 21,00
20	cromo-oro	chrome-gold	€ 27,00
08	bianco-cromo	white-chrome	€ 25,00
28	bianco-oro	white-gold	€ 27,00
13	oro	gold	€ 32,00
18	bronzo	bronze	€ 32,00

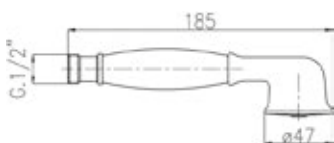

040-W

Doccia "Liberty" monogetto con impugnatura in ABS bianco; attacco da 1/2".

1/2" "Liberty" one-jet handshower with white ABS grip.

00 cromo [chrome](#) € 19,00

722

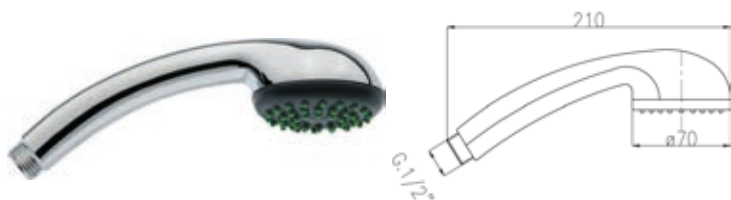

Doccia "Gommina" monogetto attacco da 1/2".
1/2" "Gommina" one-jet handshower.

00 cromo [chrome](#) € 4,60

AC790



Doccia "Class" monogetto attacco 1/2".
1/2" "Class" one-jet handshower.

00 cromo [chrome](#) € 10,00

8900



Doccia "Young" monogetto attacco 1/2".
1/2" "Young" one-jet handshower.

00 cromo [chrome](#) € 8,40

2560



Doccia "Eletta" monogetto attacco 1/2".
1/2" "Eletta" one-jet handshower.

00 cromo [chrome](#) € 4,20
08 bianco-cromo [white-chrome](#) € 4,20

Docce
Handshower

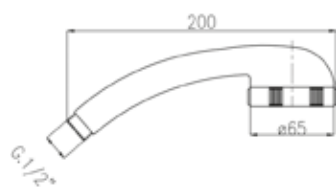

5730

Doccia "Reguline" a due getti attacco 1/2".
1/2" "Reguline" two-jet handshower.

00 cromo chrome € 17,00

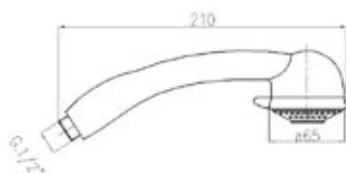

10920

Doccia "Drupi" a due getti attacco 1/2".
1/2" "Drupi" two-jet handshower.

00 cromo chrome € 19,80

08 bianco-cromo white-chrome € 19,80

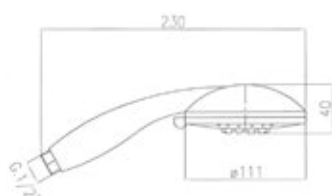

D0740

Doccia "Tris" a tre getti autopulente attacco da 1/2".
1/2" "Tris" self-cleaning three-jet handshower.

00 cromo chrome € 10,80

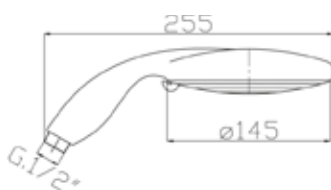

D0741

Doccia "Tris" maxi a tre getti autopulente attacco da 1/2".
1/2" "Tris" maxi self-cleaning three-jet handshower.

00 cromo chrome € 16,20

D0742

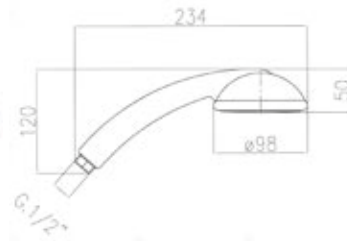

Doccia "Confort" a tre getti autopulente attacco da 1/2".
1/2" "Confort" self-cleaning three-jet handshower.

00 cromo [chrome](#) € 12,80

048

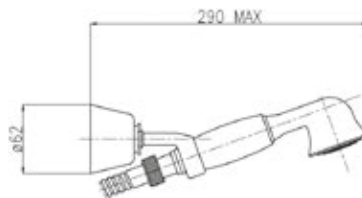

Doccia duplex "Liberty" attacco conico e flessibile
cm.150 da 1/2".

1/2" "Liberty" duplex handshower, conical connection
and 150 cm. flexible hose.

00 cromo [chrome](#) € 48,00
20 cromo-oro [chrome-gold](#) € 62,00
08 bianco-cromo [white-chrome](#) € 57,00
28 bianco-oro [white-gold](#) € 62,00
13 oro [gold](#) € 76,00
18 bronzo [bronze](#) € 76,00

2565

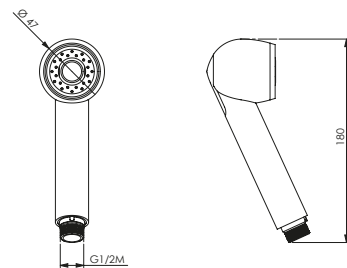

Doccia monoforo a due getti per monocomando
lavello cucina attacco da 1/2".

1/2" two-jet handshower for single lever sink mixer.

00 cromo [chrome](#) € 16,00

695



Valvola di non ritorno in ottone cromato F. 1/2"xM. 1/2".
Chrome-plated brass non return valve F. 1/2"xM. 1/2".

00 cromo [chrome](#) € 4,50

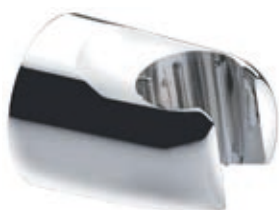

Supporti doccia
Shower supports

047

Supporto doccia duplex in ottone cromato "Liberty".
"Liberty" chromed-plated brass support for duplex handshower.

00	cromo	chrome	€ 25,00
20	cromo-oro	chrome-gold	€ 32,00
08	bianco-cromo	white-chrome	€ 30,00
28	bianco-oro	white-gold	€ 32,00
13	oro	gold	€ 39,00
18	bronzo	bronze	€ 39,00

11710

Supporto doccia duplex "Futurist" universale in ABS.
ABS universal support "Futurist" for duplex handshower.

00	cromo	chrome	€ 5,00
13	oro	gold	€ 10,00

2580

Supporto doccia duplex universale in ABS.
ABS universal support for duplex handshower.

00	cromo	chrome	€ 5,00
13	oro	gold	€ 10,00

16800

Supporto doccia duplex "Quadric" universale in ABS.
ABS universal support "Quadric" for duplex handshower.

00	cromo	chrome	€ 8,00
----	-------	--------	--------

AC715

Supporto in ABS cromato con attacco conico per doccia.
Chrome-plated ABS support with conical connection for handshower.

00	cromo	chrome	€ 2,50
----	-------	--------	--------

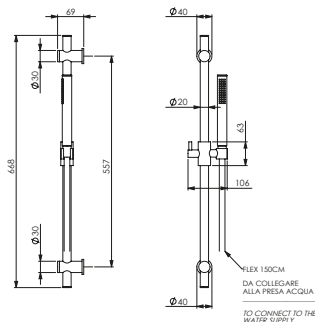

12550

Set saliscendi doccia composto da asta in ottone cromato, doccia in ABS cromato 1 getto e flessibile 150 cm. chromalux.

Shower set with sliding rail chromed brass, chromed ABS handshower 1 jet and flexible hose chromalux 150 cm.

00 cromo chrome € 100,00

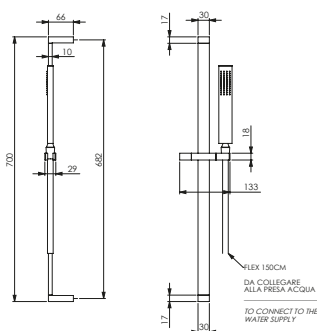

16550

Set saliscendi doccia composto da asta rettangolare inox cromata, doccia in ottone cromato 1 getto e flessibile 150 cm. chromalux.

Shower set with rectangular sliding rail chromed inox, chromed brass handshower 1 jet and flexible hose chromalux 150 cm.

00 cromo chrome € 140,00

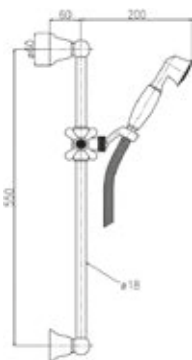

046

Set saliscendi doccia composto da asta in ottone cromato, doccia in ottone cromato 1 getto e flessibile 150 cm.

Shower set with brass sliding rail chromed, chromed brass handshower 1 jet, and flexible hose 150cm.

00 cromo chrome € 150,00
20 cromo-oro chrome-gold € 187,00
13 oro gold € 225,00
18 bronzo bronze € 225,00

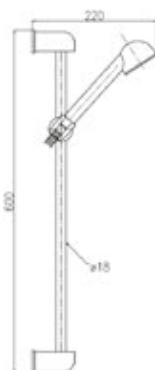

SD791

Saliscendi 60 cm. completo di doccia "Eletta" e flessibile 150 cm.

Slide rail 60 cm. With "Eletta" handshower and 150 cm. flexible hose.

00 cromo chrome € 25,00

Saliscendi
Slide rail

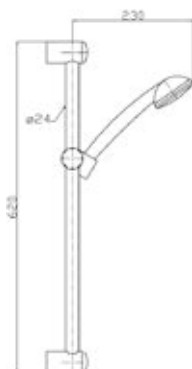
**SD792**

Saliscendi 60 cm. Completo di doccia art AC.790 e flessibile 150 cm.

Slide rail 60 cm. with handshower art.AC790 and 150 cm. flexible hose.

00 cromo chrome € 36,00

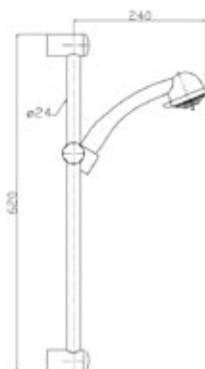
**SD795**

Saliscendi 60cm. completi di doccia "Drupy" due getti art.10920 e flessibile 150cm.

Slide rail 60 cm. with two-jet "Drupy" handshower art.10920 and 150 cm. flexible hose.

00 cromo chrome € 45,00

**SD798**

Saliscendi 60cm.completo di doccia "Young" e flessibile 150cm.

Slide rail 60 cm. with "Young" handshower and 150 cm. flexible hose.

00 cromo chrome € 28,00

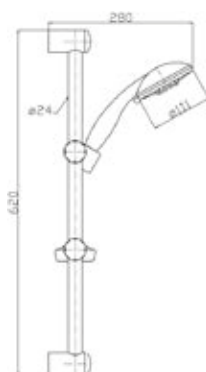
**SD500**

Saliscendi 60cm. completo di doccia "Tris" autopulente art D0740 e flessibile 150 cm.

Slide rail 60 cm. with "Tris" handshower self-cleaning handshower art.D0740 and 150 cm. flexible hose.

00 cromo chrome € 36,00

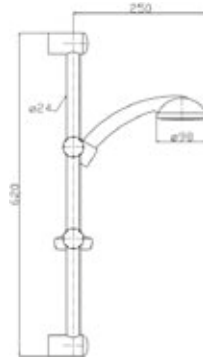

SD502

saliscendi cm60 completo di doccia "Confort" tre getti autopulente art.D0742 e flessibile 150 cm.
Slide rail 60 cm. With "Confort" 3-jet self-cleaning handshower art.D0742 and 150 cm. Flexible hose.

00 cromo chrome € 38,00

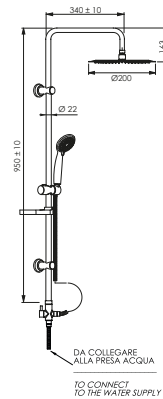

SC100

Set colonna tonda con asta in inox cromato Ø 21 mm, soffione in ABS cromato Ø 200 mm, doccia in ABS cromato a 5 getti, flessibile 40 cm e flessibile 150 cm, completo di deviatore.
Steel chromed column set with round rail Ø 21 mm, chromed ABS headshower Ø 200 mm, chromed ABS handshower 5 jets, flexible hose 40 cm and flexible hose 150 cm double lock, diverter included.

00 cromo chrome € 150,00

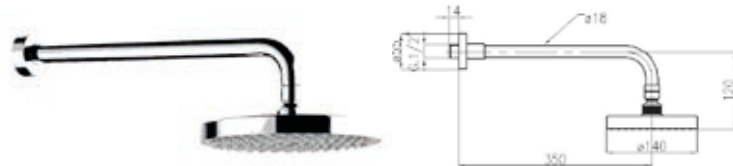

AC140

Braccio doccia lunghezza 350 mm completo di soffione anticalcare Ø140 mm.
Shower arm 350 mm long with Ø140 mm anti-lime system shower head.

00 cromo chrome € 150,00

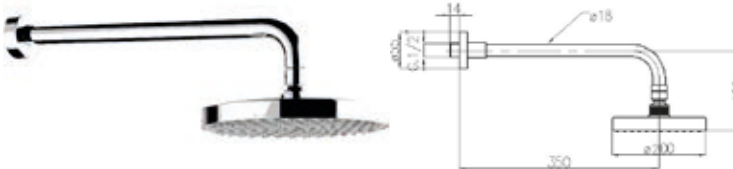

AC200

Braccio doccia lunghezza 350 mm completo di soffione anticalcare Ø200 mm.
Shower arm 350 mm long with Ø200 mm anti-lime system shower head.

00 cromo chrome € 170,00



16600

Braccio doccia lunghezza 350 mm completo di soffione anticalcare 200x200 mm.
Shower arm 350 mm long with 200x200 mm self-cleaning shower head.

00 cromo chrome € 260,00



0186

Braccio doccia lunghezza 200 mm completo di soffione jet anticalcare.
Shower arm 200 mm long complete with jet self-cleaning shower head.

00 cromo chrome € 56,00
20 cromo-oro chrome-gold € 73,00
08 bianco-cromo white-chrome € 67,00
28 bianco-oro white-gold € 73,00
13 oro gold € 90,00

Bracci doccia con soffione
Shower arms with shower head



AC300

Soffione in ottone cromato tondo Ø 300 x 8 mm, anticalcare.

Round chromed brass headshower Ø 300 x 8 mm, with easy-clean.

00 cromo chrome € 189,00

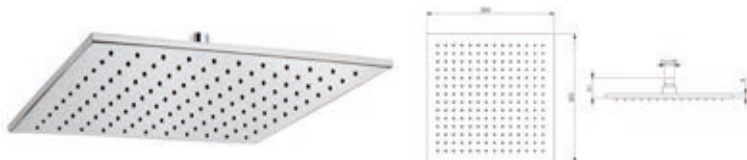

16630

Soffione in ottone cromato quadro 300x300x8 mm, anticalcare.

Square chromed brass headshower 300x300x8 mm, with easy-clean.

00 cromo chrome € 195,00



AC35

Braccio doccia tondo in ottone cromato L. 350 mm.

Chromed brass round shower arm 350 mm.

00 cromo chrome € 65,00



16035

Braccio doccia quadro in ottone cromato L. 350 mm.

Chromed brass square shower arm 350 mm.

00 cromo chrome € 75,00

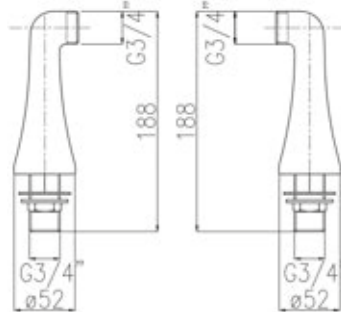

049

Coppia soprabordo vasca fissi per gruppi interasse 180 mm 3/4"x3/4".

Couple of bath connectors for 180 mm connection mixer 3/4"x3/4".

00	cromo	chrome	€ 70,00
08	bianco-cromo	white-chrome	€ 83,00
13	oro	gold	€ 108,00
18	bronzo	bronze	€ 108,00

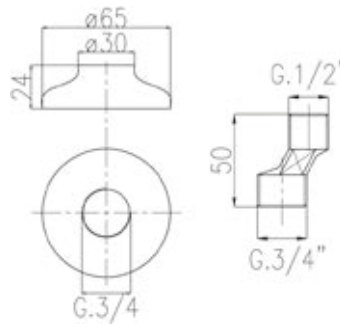

051

Coppia eccentrici con rosoni in ottone 1/2"x3/4" serie "Liberty" e "Colonial".

Couple for eccentrics with brass flanges 1/2"x3/4" for "Liberty" and "Colonial".

00	cromo	chrome	€ 12,00
08	bianco-cromo	white-chrome	€ 15,00
13	oro	gold	€ 21,00
18	bronzo	bronze	€ 21,00

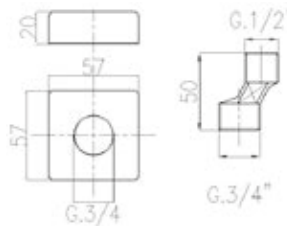

16701

Coppia eccentrici con rosoni in ottone 1/2"x3/4" serie "Quadric".

Couple of eccentrics with brass flanges 1/2"x3/4" for "Quadric" mixers.

00	cromo	chrome	€ 12,00
----	-------	--------	---------

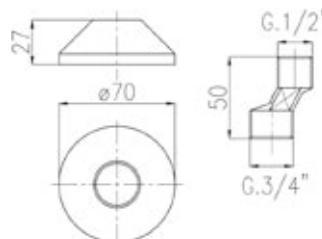

0522

Coppia eccentrici con rosoni in ottone 1/2"x3/4".

00	cromo	chrome	€ 7,50
08	bianco-cromo	white-chrome	€ 9,00
13	oro	gold	€ 14,00
18	bronzo	bronze	€ 14,00

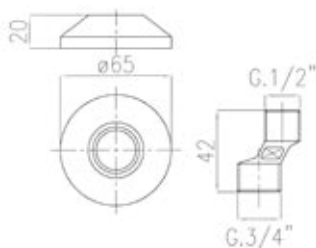
**655-40**

Coppia eccentrici con rosoni in ottone 1/2"x3/4" per "Elite" e "Panther".

Couple of eccentrics with brass flanges 1/2"x3/4" for "Elite" and "Panther".

00	cromo	chrome	€ 5,50
08	bianco-cromo	white-chrome	€ 6,50
13	oro	gold	€ 10,50
18	bronzo	bronze	€ 10,50

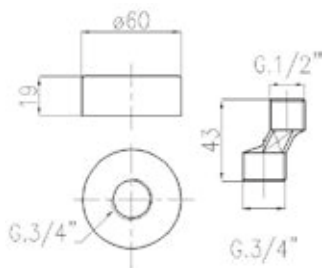
**9910**

Coppia eccentrici con rosoni in ottone 1/2"x3/4" per "Futurist".

Couple of eccentrics with brass flanges for "Futurist".

00	cromo	chrome	€ 7,00
13	oro	gold	€ 12,00

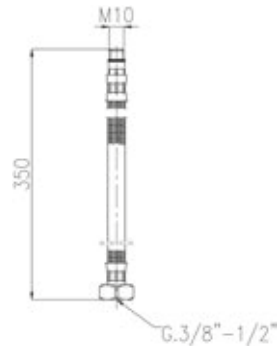

703

Coppia tubi flessibili treccia in acciaio inox Ø 10 mm per gruppi monoforo attacco maschio 10x1, femmina 1/2" o 3/8".

Couple of stainless steel flexible hoses Ø 10 mm for single-hole mixer with 10x1 male thread, female 1/2" or 3/8".

cm.	35	00	cromo	chrome	€	6,00
cm.	45	00	cromo	chrome	€	7,00
cm.	60	00	cromo	chrome	€	10,00
cm.	70	00	cromo	chrome	€	12,00

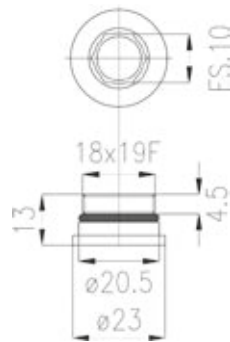

0100-01

Sede cromata per monocomando vasca, doccia, lavello.
Chrome plated seat for single-lever bath, shower and sink mixer.

00	cromo	chrome	€	1,20
----	-------	--------	---	------

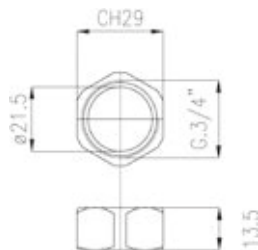

012-14

Calotta esagonale cromata 3/4" per miscelatori monocomando vasca, doccia e lavello.

3/4"chrome-plated hexagonal cap for single-lever bath, shower and sink mixer.

00	cromo	chrome	€	1,40
13	oro	gold	€	2,20

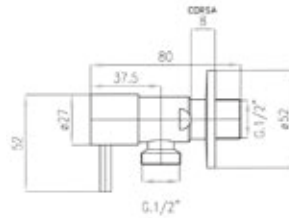

Rubinetto sottolavabo
Angle taps

13950

Rubinetto sottolavabo con rosone, vitone a dischi ceramici.
Angle tap with flange, ceramic-disc valve.

1/2"x3/8"	00	cromo	chrome	€ 17,00
1/2"x1/2"	00	cromo	chrome	€ 17,00

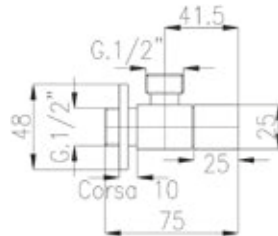

AC600

Rubinetto sottolavabo con rosone, vitone a dischi ceramici.
Angle tap with flange, ceramic-disc valve.

1/2"x3/8"	00	cromo	chrome	€ 24,00
1/2"x1/2"	00	cromo	chrome	€ 24,00

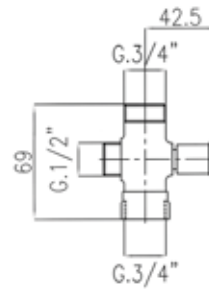

396

Deviatore a tre vie.
Three-way diverter valve.

00	cromo	chrome	€ 12,00
----	-------	--------	---------



397

Deviatore tondo a tre vie.
Three-way diverter valve.

00	cromo	chrome	€ 30,00
----	-------	--------	---------



AC545

Scarico universale click-clack 1"1/4 per lavabo e bidet.
1"1/4 universal up&down pop-up waste for basin and bidet.

00 cromo [chrome](#) € 16,00

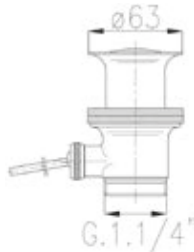

10-530

Scarico con tappo in ottone 1"1/4.
Pop-up waste with brass plug.

00 cromo [chrome](#) € 11,00

20 cromo-oro [chrome-gold](#) € 18,00

13 oro [gold](#) € 25,00

18 bronzo [bronze](#) € 23,00



10-531

Scarico con tappo in acciaio inox.
Pop-up waste with stainless steel plug.

1" 00 cromo [chrome](#) € 10,00

1"1/4 00 cromo [chrome](#) € 10,00

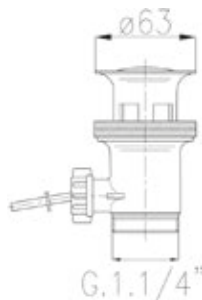

10-532

Scarico in hostaform bianco con tappo in acciaio inox.
White hostaform pop-up waste with stainless steel plug.

00 cromo [chrome](#) € 6,50



Scarichi
Pop-up waster

10-542

Snodo universale doppio cromato per aste saltarello.
Double chromed universal joint for pop-up rods.

00	cromo	chrome	€	2,20
----	-------	--------	---	------



10-543

Asta doppia 45 cm. Ø 4 mm completa di pomolo e
snodo universale doppio art. 10-542.

Double rod 45 cm. Ø 4 mm with knob and double
universal joint 10-542.

00	cromo	chrome	€	7,00
20	cromo-oro	chrome-gold	€	8,00
13	oro	gold	€	10,00
18	bronzo	bronze	€	8,00



RU 1060

Deviatore universale per rubinetto lavabo, cucina con
adattatore F. 22x1 o M. 24x1.

Universal diverter for basin tap, kitchen, with adapter
size F. 22x1 or M. 24x1.

00	cromo	chrome	€	16,00
----	-------	--------	---	-------

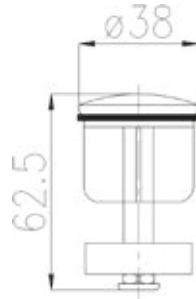

10-536

Tappo in ottone per scarico art.10.530.
Brass plug for pup-up waste art.10.530.

1"	00	Cromo	chrome	€	5,00
1"1/4	00	Cromo	chrome	€	5,00
1"	13	Oro	gold	€	9,00
1"1/4	13	Oro	gold	€	9,00



10-538

Tappo in acciaio inox per scarico 10-531 e 10-532.
Stainless steel plug for pop-up waste art.10.531-10.532.

1"	00	Cromo	chrome	€	1,70
1"1/4	00	Cromo	chrome	€	1,70

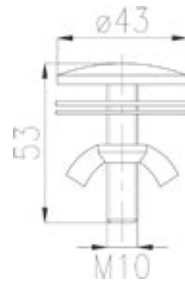

700

Tappo copriforo cromato.
Chrome-plated plug.

00	Cromo	chrome	€	4,80
13	Oro	gold	€	9,00

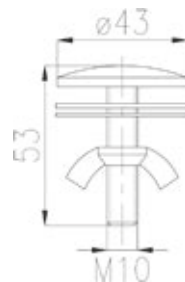

700-10

Tappo copriforo bianco.
White plug.

bianco	white	€	5,80
--------	-------	---	------

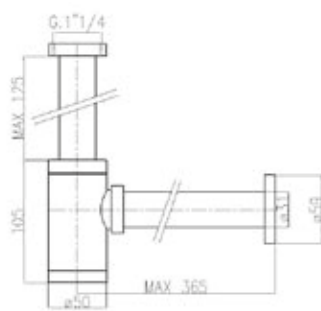

AC800

Sifone in ottone cromato per lavabo senza piletta.
Siphon in chromed brass, for washbasin without waste.

00 cromo chrome € 42,00

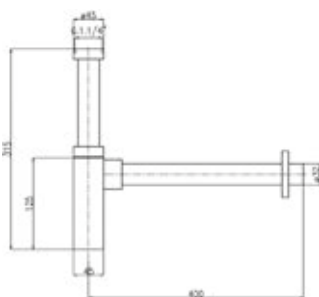

AC810

Sifone in ottone cromato per lavabo senza piletta.
Siphon in chromed brass, for washbasin without waste.

00 cromo chrome € 88,00

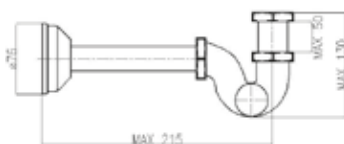

864

Sifone a "S" senza piletta per bidet.
"S" bidet trap without waste.

00 cromo chrome € 17,50

13 oro gold € 58,00

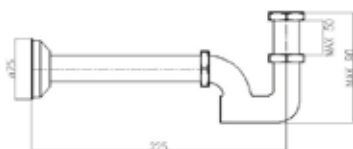

867

Sifone a colonna con ispezione senza piletta per lavabo.
Pillar trap with inspection without waste for basin.

100x100 mm 00 cromo chrome € 18,00

100x100 mm 13 oro gold € 58,00

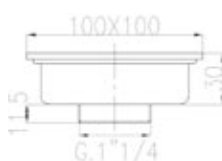

917

Pilettona a pavimento quadrato con attacco filettato 1" 1/4.
1" 1/4 square floor drain with threaded connection.

100x100 mm 00 cromo chrome € 18,00

100x100 mm 13 oro gold € 36,00

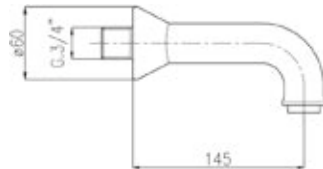

076

Bocca di erogazione a parete attacco 3/4.
3/4 wall spout.

00	cromo	chrome	€ 48,00
20	cromo-oro	chrome-gold	€ 62,00
08	bianco-cromo	white-chrome	€ 58,00
28	bianco-oro	white-gold	€ 62,00
13	oro	gold	€ 80,00
18	bronzo	bronze	€ 80,00

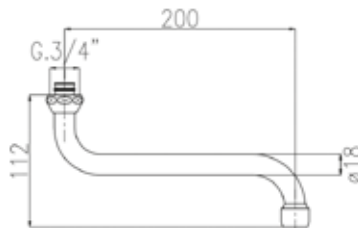

060

Bocca girevole a "S" Ø18 mm con aeratore dado attacco 3/4".
Projection "S" swivel spout Ø18mm with aerator and 3/4" nut.

mm.200	00	cromo	chrome	€ 7,00
mm.250	00	cromo	chrome	€ 8,20
mm.300	00	cromo	chrome	€ 9,40
mm.200	20	cromo-oro	chrome-gold	€ 9,10
mm.250	20	cromo-oro	chrome-gold	€ 10,60
mm.300	20	cromo-oro	chrome-gold	€ 12,20
mm.200	08	bianco-cromo	white-chrome	€ 8,40
mm.250	08	bianco-cromo	white-chrome	€ 9,80
mm.300	08	bianco-cromo	white-chrome	€ 11,30
mm.200	28	bianco-oro	white-gold	€ 9,10
mm.250	28	bianco-oro	white-gold	€ 10,60
mm.300	28	bianco-oro	white-gold	€ 12,20
mm.200	13	oro	gold	€ 13,50
mm.250	13	oro	gold	€ 14,00
mm.300	13	oro	gold	€ 15,00
mm.200	18	bronzo	bronze	€ 13,50
mm.250	18	bronzo	bronze	€ 14,00
mm.300	18	bronzo	bronze	€ 15,00

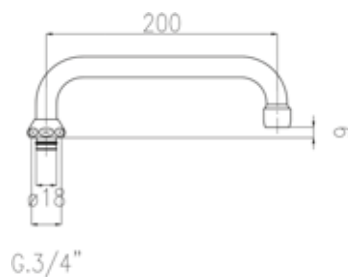

062

Bocca girevole a "U" Ø18 mm con aeratore e dado da 3/4".
Projection "U" swivel spout Ø18mm with aerator and 3/4" nut.

mm.200	00	cromo	chrome	€ 7,00
mm.250	00	cromo	chrome	€ 8,20
mm.200	20	cromo-oro	chrome-gold	€ 9,10
mm.250	20	cromo-oro	chrome-gold	€ 10,60
mm.200	08	bianco-cromo	white-chrome	€ 8,40
mm.250	08	bianco-cromo	white-chrome	€ 9,80
mm.200	28	bianco-oro	white-gold	€ 9,10
mm.250	28	bianco-oro	white-gold	€ 10,60
mm.200	13	oro	gold	€ 13,50
mm.250	13	oro	gold	€ 14,50
mm.200	18	bronzo	bronze	€ 13,50
mm.250	18	bronzo	bronze	€ 14,50

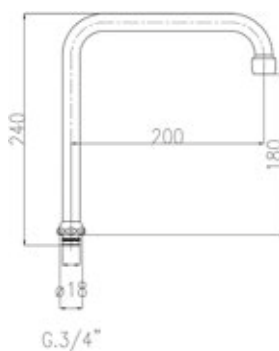
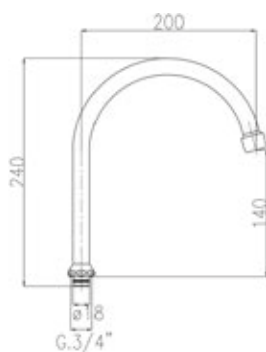
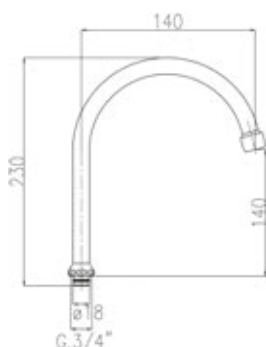
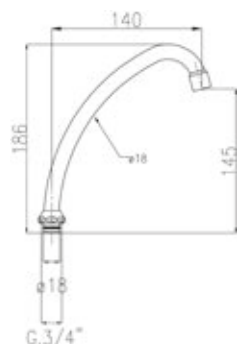

Bocche di erogazione Spout

064

Bocca girevole a "J" Ø 18 mm con aeratore dado da 3/4".
Projection "J" swivel spout Ø 18 mm with aerator and 3/4" nut.

mm. 140	00	cromo	chrome	€ 6,20
mm. 180	00	cromo	chrome	€ 8,20
mm. 140	20	cromo-oro	chrome-gold	€ 8,20
mm. 180	20	cromo-oro	chrome-gold	€ 10,60
mm. 140	08	bianco-cromo	white-chrome	€ 7,50
mm. 180	08	bianco-cromo	white-chrome	€ 9,80
mm. 140	28	bianco-oro	white-gold	€ 8,20
mm. 180	28	bianco-oro	white-gold	€ 10,60

065

Bocca girevole alta Ø 18 mm con aeratore dado da 3/4".
High projection swivel spout Ø 18 mm with aerator and 3/4" nut.

mm. 140	00	cromo	chrome	€ 10,00
mm. 140	20	cromo-oro	chrome-gold	€ 13,00
mm. 140	08	bianco-cromo	white-chrome	€ 12,00
mm. 140	28	bianco-oro	white-gold	€ 13,00
mm. 140	13	oro	gold	€ 18,00
mm. 140	18	bronzo	bronze	€ 18,00

066

Bocca girevole alta Ø 18 mm con aeratore, dado da 3/4".
High projection swivel spout Ø 18 mm with aerator and 3/4" nut.

mm. 200	00	cromo	chrome	€ 11,00
mm. 200	20	cromo-oro	chrome-gold	€ 14,30
mm. 200	08	bianco-cromo	white-chrome	€ 13,20
mm. 200	28	bianco-oro	white-gold	€ 14,30
mm. 200	13	oro	gold	€ 19,60
mm. 200	18	bronzo	bronze	€ 19,60

067

Bocca girevole alta HU Ø 18 mm con aeratore dado da 3/4".
High HU projection swivel spout Ø 18 mm with aerator and 3/4" nut.

mm. 200	00	cromo	chrome	€ 9,40
mm. 200	20	cromo-oro	chrome-gold	€ 12,50
mm. 200	08	bianco-cromo	white-chrome	€ 11,50
mm. 200	28	bianco-oro	white-gold	€ 12,50
mm. 200	13	oro	gold	€ 16,00
mm. 200	18	bronzo	bronze	€ 16,00



068

Bocca girevole in tubo con aeratore, dado da 3/4".
Shaped tubular projection swivel spout with aerator and 3/4" spout.

mm. 120	00	cromo	chrome	€ 13,00
mm. 200	00	cromo	chrome	€ 15,00
mm. 300	00	cromo	chrome	€ 19,20
mm. 120	20	cromo-oro	chrome-gold	€ 17,00
mm. 200	20	cromo-oro	chrome-gold	€ 19,00
mm. 300	20	cromo-oro	chrome-gold	€ 25,00
mm. 120	08	bianco-cromo	white-chrome	€ 16,00
mm. 200	08	bianco-cromo	white-chrome	€ 18,00
mm. 300	08	bianco-cromo	white-chrome	€ 23,00
mm. 120	28	bianco-oro	white-gold	€ 17,00
mm. 200	28	bianco-oro	white-gold	€ 19,00
mm. 300	28	bianco-oro	white-gold	€ 25,00
mm. 120	13	oro	gold	€ 21,00
mm. 200	13	oro	gold	€ 23,00
mm. 300	13	oro	gold	€ 31,00
mm. 120	18	bronzo	bronze	€ 21,00
mm. 200	18	bronzo	bronze	€ 23,00
mm. 300	18	bronzo	bronze	€ 31,00

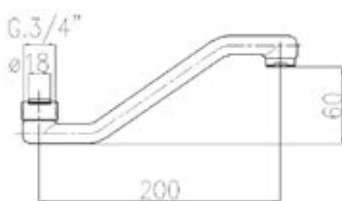

069

Bocca girevole in tubo alzata con aeratore dado 3/4".
Tubular upward projection swivel spout with aerator and 3/4" nut.

mm. 200	00	cromo	chrome	€ 14,00
mm. 200	20	cromo-oro	chrome-gold	€ 18,50
mm. 200	08	bianco-cromo	white-chrome	€ 17,00
mm. 200	28	bianco-oro	white-gold	€ 18,50
mm. 200	13	oro	gold	€ 23,00
mm. 200	18	bronzo	bronze	€ 23,00



070

Bocca girevole per lavabo Ø 25 mm con aeratore, dado da 3/4".
Projection basin swivel spout Ø 25 mm with aerator and 3/4" nut.

mm. 180	00	cromo	chrome	€ 22,00
mm. 180	20	cromo-oro	chrome-gold	€ 29,00
mm. 180	08	bianco-cromo	white-chrome	€ 27,00
mm. 180	28	bianco-oro	white-gold	€ 29,00
mm. 180	18	bronzo	bronze	€ 35,00

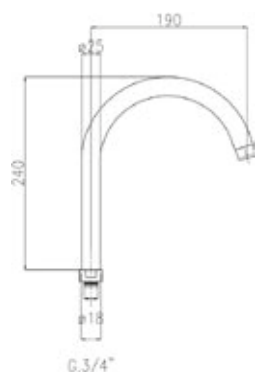
**072**

Bocca girevole alta per lavello Ø 25 mm con aeratore, dado da 3/4".

High projection sink swivel spout Ø 25 mm with aerator and 3/4" nut.

mm. 250	00	cromo	chrome	€ 26,00
mm. 250	20	cromo-oro	chrome-gold	€ 34,00
mm. 250	08	bianco-cromo	white-chrome	€ 32,00
mm. 250	28	bianco-oro	white-gold	€ 34,00
mm. 250	18	bronzo	bronze	€ 42,00

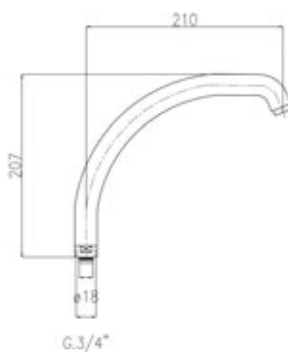
**074**

Bocca girevole in tubo sagomato con aeratore, dado da 3/4".

Shaped tubular projection swivel spout with aerator and 3/4" nut.

mm. 210	00	cromo	chrome	€ 20,00
mm. 210	20	cromo-oro	chrome-gold	€ 26,00
mm. 210	08	bianco-cromo	white-chrome	€ 24,00
mm. 210	28	bianco-oro	white-gold	€ 26,00
mm. 210	18	bronzo	bronze	€ 32,00

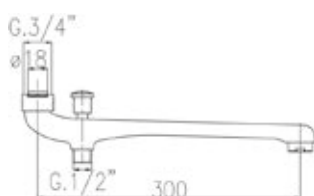
**075**

Bocca girevole fusa 300mm completa di deviatore, dado da 3/4".

Cast projection 300 mm swivel spout with diverter and 3/4" nut.

mm. 300	00	cromo	chrome	€ 65,00
mm. 300	20	cromo-oro	chrome-gold	€ 81,00
mm. 300	08	bianco-cromo	white-chrome	€ 76,00

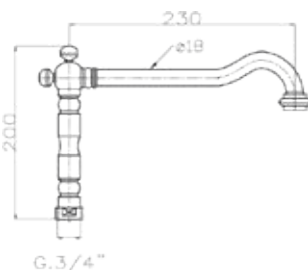
**B80**

Bocca girevole stile antico con aeratore.

Swivel spout antique style with aerator.

mm. 230	00	cromo	chrome	€ 86,00
mm. 230	08	bianco-cromo	white-chrome	€ 136,00
mm. 230	13	oro	gold	€ 150,00
mm. 230	18	bronzo	bronze	€ 150,00



0506

Aeratore filetto maschio Ø 28x1 per vasca.
Male aerator Ø 28x1 for bath mixer.

00	cromo	chrome	€	2,00
13	oro	gold	€	4,00
18	bronzo	bronze	€	4,00

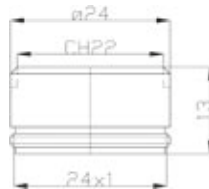

0508

Aeratore filetto maschio Ø 24x1 per lavabo.
Male aerator Ø 24x1 for basin mixer.

00	cromo	chrome	€	1,70
13	oro	gold	€	3,40
18	bronzo	bronze	€	3,40

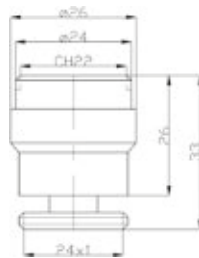

0510

Aeratore a snodo filetto maschio Ø 24x1 per bidet.
Jointed male aerator Ø 24x1 for bidet mixer.

00	cromo	chrome	€	4,50
13	oro	gold	€	10,80
18	bronzo	bronze	€	10,80

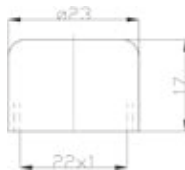

0512

Aeratore filetto femmina Ø 22x1 per lavello.
Female aerator Ø 22x1 for sink mixer.

00	cromo	chrome	€	1,40
13	oro	gold	€	3,40
18	bronzo	bronze	€	3,40

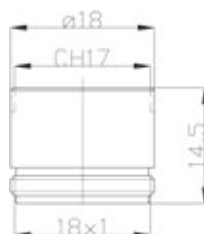

13100/04

Aeratore filetto maschio Ø 18x1 per lavabo serie "Futurist".
Male aerator Ø 18x1 for "Futurist" basin mixer.

00	cromo	chrome	€	3,20
13	oro	gold	€	6,10

**13700/05**

Aeratore filetto femmina Ø 16x1 per lavello serie "Futurist".
Female aerator Ø 16x1 for "Futurist" sink mixer.

00	cromo	chrome	€	3,50
13	oro	gold	€	6,70

**13200/05**

Aeratore a snodo filetto maschio Ø 18x1 per bidet "Futurist".
Jointed male aerator Ø 18x1 for "Futurist" bidet mixer.

00	cromo	chrome	€	7,50
13	oro	gold	€	14,40

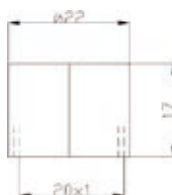
**13200/06**

Aeratore filetto femmina Ø 20x1 per lavello.
Female aerator Ø 20x1 for sink mixer.

00	cromo	chrome	€	2,60
13	oro	gold	€	5,20

**TH201**

Aeratore per monocomando lavabo/vasca serie "Thin".
Aerator for single lever basin/bath mixer range "Thin".

€ 3,50

**TH301**

Aeratore a snodo per monocomando bidet serie "Thin".
Jointed aerator for single lever bidet mixer range "Thin".

00	cromo	chrome	€	12,00
----	-------	--------	---	-------

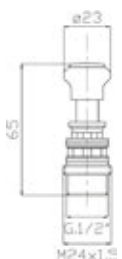
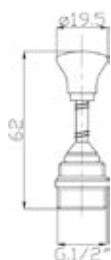
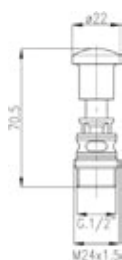

13001

Deviatore completo di pomolo per monocomando vasca serie "Futurist".

Diverter with knob for "Futurist" single-lever bath mixer.

00 cromo chrome € 10,00

0101

Deviatore completo di pomolo per monocomando vasca serie "Elite".

Diverter with knob for "Elite" single-lever bath mixer.

00 cromo chrome € 6,50

13 oro gold € 11,60

1051

Deviatore completo di pomolo per monocomando vasca serie "Panther".

Diverter with knob for "Panther" single-lever bath mixer.

00 cromo chrome € 6,50

7001

Deviatore completo di pomolo per monocomando vasca serie "Colonial".

Diverter with knob for "Colonial" single-lever bath mixer.

00 cromo chrome € 10,00

13 oro gold € 15,00

18 bronzo bronze € 15,00

TH101

Deviatore per monocomando vasca serie "Thin".

"Thin" series single lever bath diverter.

00 cromo chrome € 10,00

TH102

Maniglia per deviatore serie "Thin".

Diverter knob for range "Thin".

00 cromo chrome € 7,00

Basette
Base ring

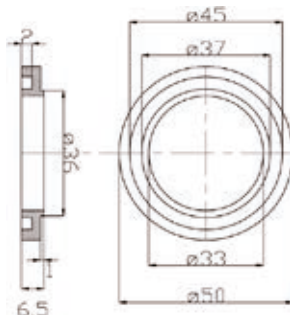
**13000/14**

Base per miscelatore in ottone cromato serie "Futurist".
Brass chrome-plated base ring for range "Futurist".

00	cromo	chrome	€	5,00
----	-------	--------	---	------

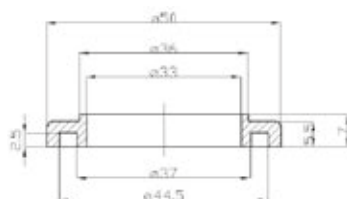
**1068/15**

Base per miscelatore in ABS cromato per monocomando
lavabo/bidet Ø 35 mm.

Chrome-plated ABS base ring for single-lever basin/
bidet mixer Ø 35 mm.

00	cromo	chrome	€	0,60
13	oro	gold	€	1,20

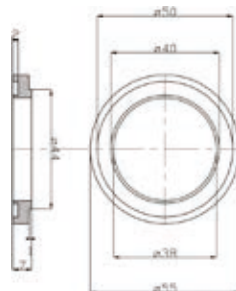
**5100/02**

Base per miscelatore in ottone cromato per miscelatore
lavabo/bidet serie "Liberty".

Brass chrome-plated base ring for single-lever basin/
bidet mixer range "Liberty".

00	cromo	chrome	€	6,00
----	-------	--------	---	------

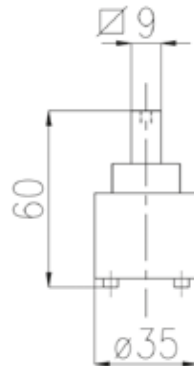

1130

Cartuccia Ø 35 mm a dischi ceramici per miscelatori serie "Panther, Colonial, Futurist, Quadric, Arial".
Ceramic-disc cartridge Ø35 mm for range "Panther, Colonial, Futurist, Quadric, Arial".

Ø 35mm articolo item € 5,20

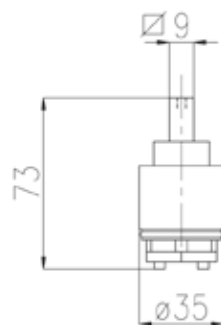

1140

Cartuccia Ø 35 mm a dischi ceramici con distributore per miscelatori serie "Panther, Colonial".
Ceramic-disc cartridge Ø 35 mm with distributor for range "Panther, Colonial".

Ø 35mm articolo item € 5,20

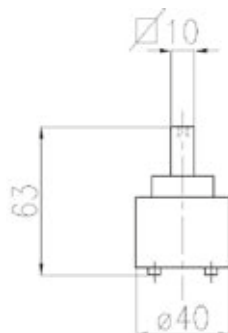

0200

Cartuccia Ø 40 mm a dischi ceramici per miscelatori serie "Teco, Elite".

Ceramic-disc cartridge Ø 40 mm for range "Teco, Elite".

Ø 40mm articolo item € 6,40

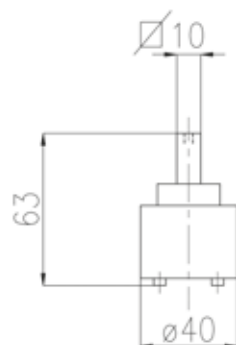

0200-C

Cartuccia click-clack Ø 40 mm a dischi ceramici.

Ceramic-disc cartridge click-clack for mixer Ø 40 mm.

Ø 40mm articolo item € 10,00

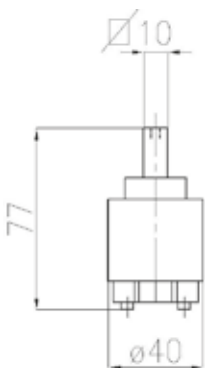
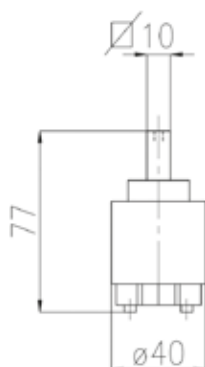

Cartucce
Cartridges

0201

Cartuccia Ø 40 mm a dischi ceramici con distributore per miscelatori serie "Elite".

[Ceramic-disc cartridge Ø 40 mm for range "Elite".](#)

Ø 40mm articolo [item](#) € 6,40

0201-C

Cartuccia Ø 40 mm click-clack a dischi ceramici con distributore per miscelatori serie "Elite".

[Click-clack ceramic-disc cartridge Ø 40 mm for range "Elite".](#)

Ø 40mm articolo [item](#) € 10,00

TH 25

Cartuccia Ø 25 dischi ceramici per miscelatori serie "Thin" monocomando lavabo e bidet.

[Cartridge Ø 25 ceramic discs for "Thin" series mixers single lever sink and bidet.](#)

Ø 25mm articolo [item](#) € 12,00

TH 30

Cartuccia Ø 30 dischi ceramici per miscelatori serie "Thin" monocomando lavabo e bidet.

[Cartridge Ø 30 ceramic discs for "Thin" series mixers single lever sink and bidet.](#)

Ø 30mm articolo [item](#) € 12,00



FU TERMO

Cartuccia termostatica per art. 13230 serie "Futurist".
[Thermostatic cartridge for art. 13230 "Futurist" series.](#)

..... articolo item €	52,00
----------------	------------	---------	-------

TH TERMO

Cartuccia termostatica per art. TH 450 serie "Thin".
[Thermostatic cartridge for art. TH 450 "Thin" series.](#)

..... articolo item €	52,00
----------------	------------	---------	-------

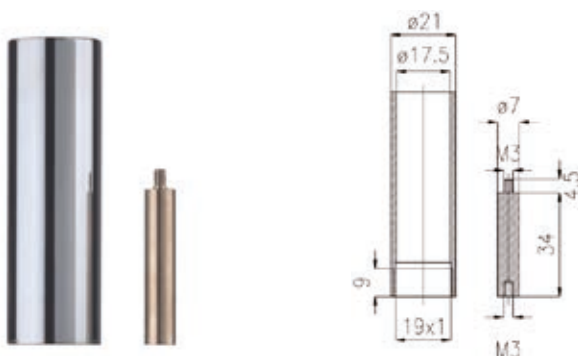
**PRO101**

Kit prolunga per deviatore monocomando incasso vasca/doccia.

Extension kit for diverter of built-in single lever bath/shower mixer.

00 cromo chrome € 9,40

**PRO200**

Kit prolunga Ø 40 mm per sede cartuccia monocomando incasso doccia e vasca/doccia.

Ø 40 mm extension kit for cartridge-seat of built-in single-lever shower mixer and bath/shower mixers.

00 cromo chrome € 37,00

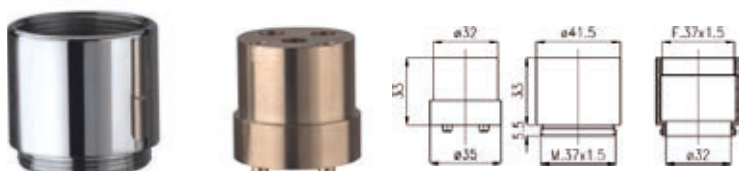
**PRO01130**

Kit prolunga Ø 35 mm per sede cartuccia monocomando incasso doccia e vasca/doccia.

Ø 35 extension kit for cartridge-seat of built-in single-lever shower mixers and bath/shower mixers.

00 cromo chrome € 37,00

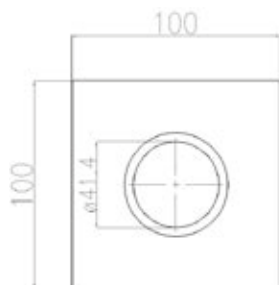

16500-50

Piastra per monocomando incasso "Quadric" art.16500.
Plate for built-in single-lever mixers "Quadric" art.16500.

00 cromo chrome € 50,00

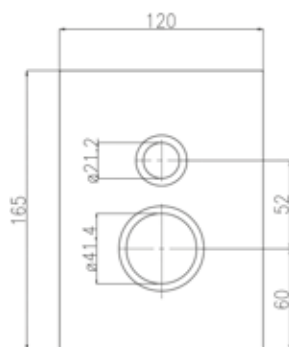

16091-50

Piastra per monocomando incasso con deviatore "Quadric" art.16091.
Plate for single-lever built-in mixers diverter "Quadric" art.16091.

00 cromo chrome € 75,00

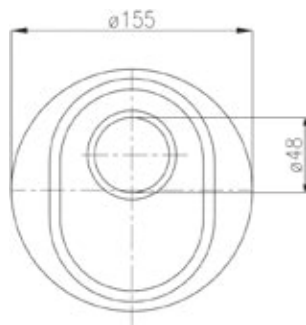

5500-50

Piastra tonda per monocomando incasso doccia serie "Colonial".
Round plate for built-in single-lever shower mixers "Colonial".

00 cromo chrome € 20,00
13 oro gold € 31,00

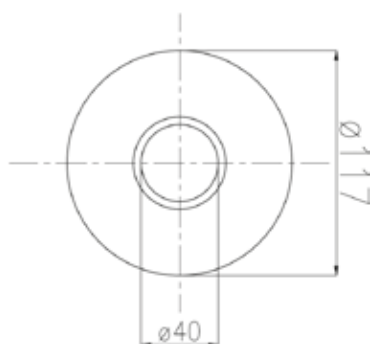

1076-50

Piastra tonda per monocomando incasso "Panther" art.1076 "Colonial" art.7500.
Round plate for built-in single-lever mixers "Panther" art.1076, "Colonial" art.7500.

00 cromo chrome € 9,00
08 bianco-cromo white-chrome € 10,60
13 oro gold € 14,00
18 bronzo bronze € 14,00

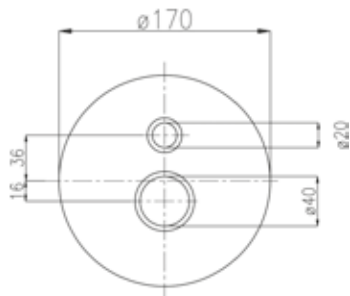
**13070-50**

Piastra tonda per monocomando incasso con deviatore "Futurist" art. 13062, 13070.

Round plate for built-in single-lever shower mixers with diverter "Futurist" art. 13062, 13070.

00 cromo chrome € 22,00

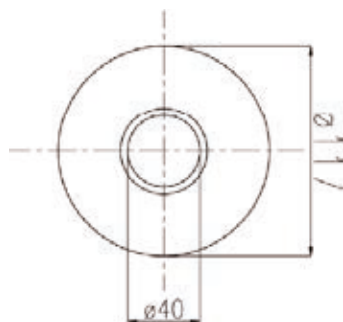
**13500-50**

Piastra tonda per monocomando incasso "Futurist" art. 13500, 13552.

Round plate for built-in single-lever mixers "Futurist" art. 13500, 13552.

00 cromo chrome € 9,00

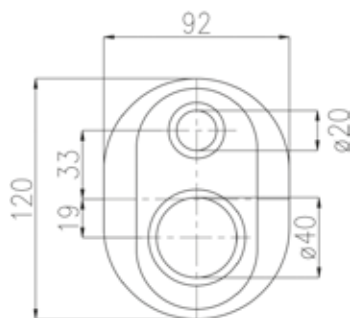
**1054-50**

Piastra per monocomando incasso doccia con deviatore "Panther" art. 1054, "Colonial" art. 7080, 7091.

Plate for built-in single-lever shower mixers with diverter "Panther" art. 1054 and "Colonial" art. 7080, 7091.

00 cromo chrome € 22,00
08 bianco-cromo white-chrome € 26,00
13 oro gold € 34,00
18 bronzo bronze € 34,00

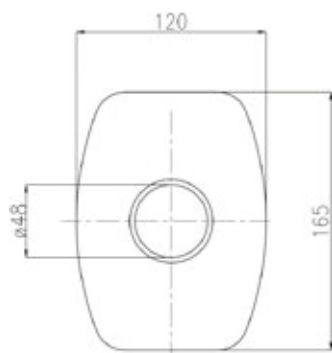
**4500-50**

Piastra per monocomando incasso doccia "Elite" art. 2360.

Plate for built-in single-lever shower mixers "Elite" art. 2360.

00 cromo chrome € 16,00

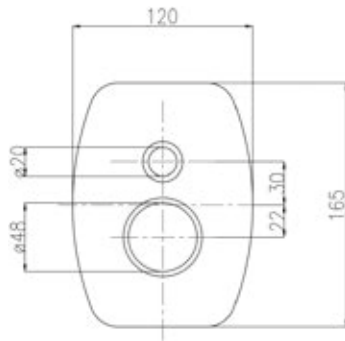

4091-50

Piastra per monocomando incasso doccia con deviatore "Elite" art.2091.

Plate for built-in single-lever shower mixers with diverter "Elite" art.2091.

00 cromo [chrome](#) € 20,00

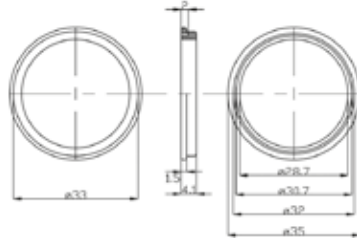
**1076/05**

Guarnizione a labbro per miscelatore monocomando
lavello con cartuccia da \varnothing 35 mm.

Lip-gasket for single-lever sink mixer with \varnothing 35 mm
cartridge.

\varnothing 35mm € 0,40

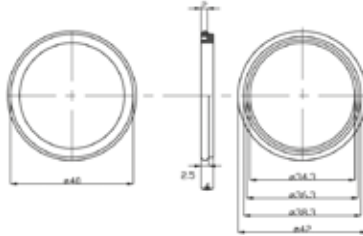
**2400/05**

Guarnizione a labbro per miscelatori monocomando
lavello con cartuccia da \varnothing 40 mm.

Lip-gasket for single-lever sink mixers with \varnothing 40
mm cartridge.

\varnothing 40mm € 0,45

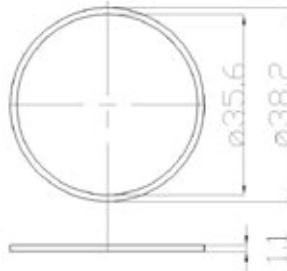
**1078/06**

Anello in teflon per miscelatori monocomando lavello
con cartuccia \varnothing 35 mm.

Teflon ring for single-lever sink mixers with \varnothing 35
mm cartridge.

\varnothing 35mm € 0,25

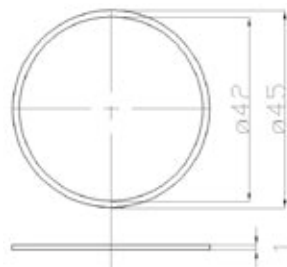
**2400/06**

Anello in teflon per miscelatori monocomando lavello
con cartuccia \varnothing 40 mm.

Teflon ring for single-lever sink mixers with \varnothing 40
mm cartridge.

\varnothing 40mm € 0,30

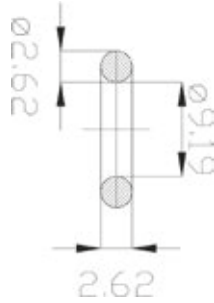

060/05

O-ring per canne Ø 14 mm.
O-ring for spouts Ø 14 mm.

Ø 14mm € 0,04

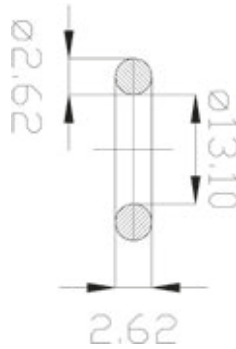

065/05

O-ring per canne Ø 18 mm.
O-ring for spouts Ø 18 mm.

Ø 18mm € 0,04

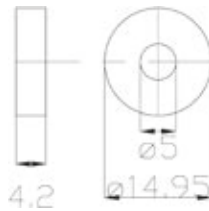

671/05

Guarnizione per valvole da 1/2"
Gasket for 1/2" valve.

1/2" € 0,10

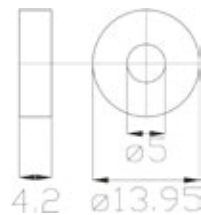

672/05

Guarnizione per valvole da 3/8"
Gasket for 3/8" valve.

3/8" € 0,08

Set Fissaggio
Fixing set

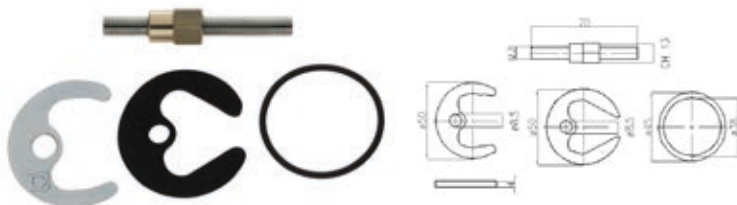

10.114

Set di fissaggio per miscelatori.
Fixing set for single-lever mixers.

Ø 35mm € 1,40

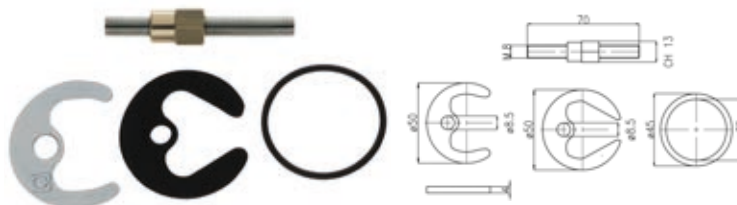

10.115

Set fissaggio per miscelatori.
Fixing set for single-lever mixers.

Ø 40mm € 1,40

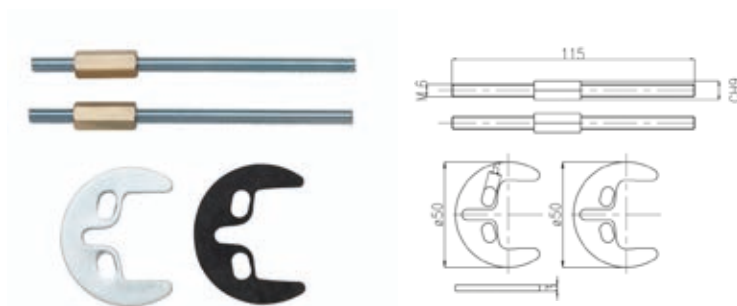

10.116

Set fissaggio per miscelatori.
Fixing set for single-lever mixers.

Ø 35mm € 1,80

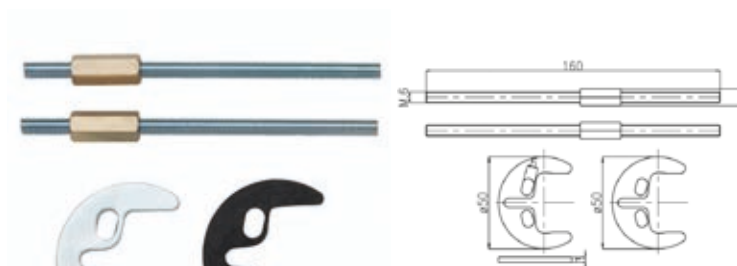

10.117

Set di fissaggio prolungato per miscelatori.
Extended fixing set for single-lever mixers.

Ø 35mm € 2,20

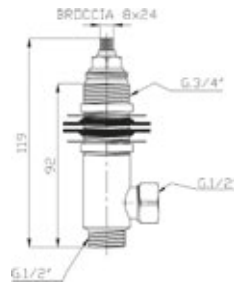

10-073

Piantana per batteria lavabo.
Basin lateral connection.

con vitone 056	with valve 056	€ 18,00
con vitone 058	with valve 058	€ 21,10

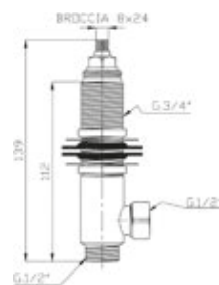

10-074

Piantana per batteria bidet.
Bidet lateral connection.

con vitone 056	with valve 056	€ 19,20
con vitone 058	with valve 058	€ 22,30



10-075

Rubinetto per bidet.
Bidet tap.

con vitone 056	with valve 056	€ 14,00
con vitone 058	with valve 058	€ 17,00

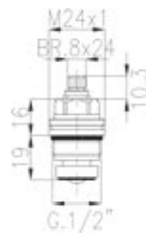

056

Vitone unificato da 1/2" con broccia Ø 8x24.
1/2" standardized valve with Ø 8x24 seat.

€ 3,00

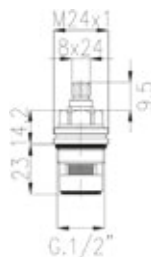

058

Vitone unificato da 1/2" a dischi ceramici, rotazione a 90°, chiusura destra broccia Ø 8x24.
1/2" standardized ceramic disc valve, 90° rotation, ring closing Ø 8x24 seat.

€ 6,00

MADE IN ITALY



Condizioni generali di vendita

Le presenti condizioni generali regolano ogni contratto di vendita posto in essere con la società: Bugatti Sanitary Taps S.r.l. a socio unico - Via Ruca, 38 - Lumezzane (BS) Italia, salvo s'intende eventuali deroghe espressamente concordate e sottoscritte dalle parti.

1 Formulazione degli ordini

Gli ordini dei Clienti, Agenti, Rappresentanti ed Ausiliari di Commercio dovranno essere trasmessi per iscritto secondo le forme indicate dal venditore. La ditta venditrice si ritiene completamente libera di perfezionare o meno, a suo insindacabile giudizio, l'ordine ricevuto.

2 Prezzi

I prezzi indicati nel presente listino si intendono al netto dell'imposta sul valore aggiunto (I.V.A.), che sarà applicata in base all'aliquota vigente al momento della fatturazione. I prezzi del presente listino sono soggetti a variazioni a nostro solo ed insindacabile diritto.

3 Resa della merce

Salvo patto contrario, le forniture dei prodotti s'intendono "franco fabbrica" del venditore: trasporto, assicurazione ed altri oneri restano tuttavia a carico del compratore anche quando si sia convenuto che la spedizione venga curata dal venditore, nel qual caso quest'ultimo agirà come mandatario del compratore, essendo inteso che il trasporto verrà effettuato solo ed esclusivamente a rischio del compratore.

4 Termini di consegna

I termini di consegna indicati sull'ordine s'intendono sempre indicativi e mai tassativi. È facoltà del venditore sospendere le spedizioni ed annullare gli ordini in tutti i casi di forza maggiore, quali a titolo esemplificativo ma non limitativo: casi di sciopero delle ditte fornitrici - sciopero dei trasporti - sciopero del personale Faris da qualsiasi causa determinato - sopravvenute difficoltà che ritardino o non consentano in tutto o in parte l'approvvigionamento o rendano più onerosa la fornitura, eccetera, nonché ovviamente in caso di mora o ritardo nei pagamenti. Il termine di consegna verrà prorogato per un periodo di tempo pari a quello della durata dell'impedimento verificatosi in subordine agli eventi di forza maggiore.

5 Garanzia

Il venditore garantisce la conformità dei prodotti forniti essendo gli stessi sottoposti ad accurati collaudi e tests prima di essere posti in vendita, escludendo quindi ogni vizio che potrebbe renderli non idonei all'uso cui sono destinati. La garanzia viene estesa ad ogni difetto di progettazione e fabbricazione. Il venditore non risponde per vizi o difetti dovuti a cattive manutenzioni o riparazioni effettuate in modo negligente e

senza preventiva autorizzazione della venditrice. Ogni garanzia decade in casi di accertata usura di parti che per loro natura sono soggette ad usura naturale, nonché all'uso improprio di prodotti per la pulizia contenenti acidi o sostanze abrasive.

6 Reclami

Il compratore è tenuto a verificare la conformità dei prodotti ricevuti, nonché eventuale presenza di vizi. I reclami relativi alla non conformità dei prodotti dovranno essere tassativamente notificati per iscritto, a pena di decadenza, entro e non oltre 30 (trenta) giorni dalla data di ritiro delle merci (documento di trasporto o fattura).

7 Responsabilità

La nostra responsabilità sulla qualità dei materiali si limita, previa nostra autorizzazione, ad accettare il reso in "porto franco nostro stabilimento". La sostituzione verrà effettuata tempestivamente dopo il riconoscimento dei vizi precedentemente rilevati. Qualora in sede di controllo non si dovesse riscontrare alcuna anomalia contestata, il venditore provvederà senza preavviso alcuno ad addebitare con regolare emissione di fattura quanto precedentemente inviato a sostituzione del reso.

8 Pagamenti

I termini di pagamento contemplati in fattura si intendono tassativi; ogni diversa variazione dovrà essere preventivamente concordata ed accettata dal venditore. Qualsiasi ritardo o irregolarità dei pagamenti costituirà diritto per il venditore di sospendere ogni fornitura in essere nonché tutte le ordinazioni in corso. È facoltà del venditore di addebitare gli interessi di ritardato pagamento al tasso bancario vigente per il periodo decorrente dalla data del pagamento contrattualmente pattuito. Eventuali Agenti, Rappresentanti ed Ausiliari di Commercio non sono legittimati a ricevere i pagamenti per conto del venditore, salvo espressa e specifica autorizzazione scritta, predisposta dall'azienda venditrice.

9 Riservatezza

Ai sensi dell'art. 13 D. LGS. 30-06-2003 n. 196 e dell'art. 13 Regolamento UE n. 2016/679, il titolare del trattamento dei dati personali forniti dai clienti è: Bugatti Sanitary Taps S.r.l. a socio unico - Via Ruca, 38 - Lumezzane (BS) Italia

10 Foro competente

Per qualsiasi controversia derivante o collegata ai contratti cui si applicano le presenti condizioni generali, sarà esclusivamente competente il Foro di Brescia (Italia). Tuttavia in deroga a quanto stabilito, il venditore ha la facoltà di promuovere le controversie davanti al giudice competente presso il domicilio del cliente.

General sales conditions

These general conditions govern every sales contract drawn up with Bugatti Sanitary Taps S.r.l. - Via Ruca, 38 - Lumezzane (BS) Italy, except whenever any departures from the terms are expressly agreed and underwritten by the parties concerned.

1 Order Formulation

The orders from Customers, Agents, Representatives and Dealers must be sent in writing according to the methods stated by seller. The seller considers itself to be completely free to decide, at its own final judgement, whether or not to sign and/or execute the order received.

2 Prices

The prices shown in this price list are understood to be net of value added tax (V.A.T.) which will be applied according to the rate in force when the invoices are issued. We reserve the unquestionable right to vary the prices given in this price list.

3 Delivery of the goods

Unless otherwise agreed, the delivery of the products is understood to be "ex-works" at the seller's factory: freight costs, insurance and other charges are therefore at the buyer's expense even if it has been agreed that delivery will be handled by seller. In the latter case, the seller will act as the buyer's representative, as it is understood that the transport will be carried out solely and exclusively at the buyer's risk.

4 Terms of delivery

The terms of delivery stated in the order are understood at all times to be approximate and never binding. It is the seller's right to suspend deliveries and cancel orders in all cases of force majeure, as in the following examples that are not exhaustive: cases of strikes by supplying companies, transport strikes, strikes by the staff at Faris for whatever reason, problems that may arise that delay or prevent purchasing or that make the supply to the buyer more difficult, etcetera, and obviously cases of arrears or delays in payment. The terms of delivery will be extended for a period of time equal to that of the duration of the impediment that has occurred as a result of the circumstances of force majeure.

5 Guarantee

The seller guarantees the conformity of the products supplied as they are subject to rigorous inspections and tests before being placed on the market so that all faults that could make them unsuitable for the purpose for which they are designed are excluded. The guarantee covers all design and manufacturing faults. The seller will not be responsible for any defects or faults that may arise as a result of inadequate maintenance or repairs carried out negligently and without prior authorization from the seller. All guarantees will become

null and void if the parts are found to have worn as a result of natural wear due to their product type or if they have been cleaned using unsuitable products containing acids or abrasive substances.

6 Complaints

The buyer is responsible for checking the compliance of the products received as well as checking for any faults. Any complaints concerning the non-compliance of the products must be notified in writing within 30 (thirty) days, under penalty of nullity, from collection of the goods (transport document or invoice).

7 Responsibility

Our responsibility with regard to the quality of the materials is limited, once our prior authorization has been obtained, to accepting returned goods "carriage free at our factory". The goods will be replaced in good times as soon as the faults previously pointed out have been recognized. If, during the inspections, none of the contested faults should be found, the seller will take steps, without prior notice, to charge for the goods previously sent as a replacement for the returned goods by issuing a regular invoice for the same.

8 Payments

The terms of payment stated in the invoice are understood to be binding. Any variation to such terms must be agreed in advance and accepted by the seller. Any delay or irregularity in the payments will give the seller the right to suspend any supply in progress as well as all the orders on hand. It is the seller's right to charge interest on the delayed payment at the bank interest rate in force for the period starting from the due of payments as contractually agreed. Agents, Representatives and Dealers are not authorized to collect payments on behalf of the seller, unless permitted to do so with express and specific written authorization provided in advance by the seller.

9 Privacy

In accordance with art. 13 Legislative Decree 30-06-2003 n. 196 and art. 13 EU Regulation no. 2016/679, the company responsible for dealing with the personal data supplied by the customers is: Bugatti Sanitary Taps S.r.l. - Via Ruca, 38 - Lumezzane (BS) Italy.

10 Competent court of law

For any controversy deriving from or connected with the contracts to which these general conditions apply, the competent court of law will be that of Brescia (Italy). However, as an exception to the conditions established, the seller has the faculty to start legal proceedings concerning controversies at a competent law court in the customer's place of residence.



BUGATTI SANITARY TAPS s.r.l.

Via Ruca, 38 - 25065 Lumezzane (Brescia) Italia
tel +39 030 2752768 fax +39 030 2752768
www.bugattisanitary.it info@bugattisanitary.it