



 **mobilità ridotta**
reduced mobility



Una percentuale importante della popolazione è costituita da persone con deficit motori o sensoriali e le strutture quali **ospedali, cliniche, case di cura...** non sempre sono idoneamente attrezzate nell'ambiente bagno per consentire alle persone in condizione di disabilità una gestione autonoma e sicura della propria intimità.

Sondaggi a personale specializzato hanno evidenziato la necessità di investire in materia.

Alpi si è impegnata in tal senso avvalendosi della collaborazione di esperti per trovare soluzioni innovative e corrette.

*A significant percentage of the population consists of people with sensory or motor deficits and facilities such as **hospitals, clinics and nursing homes etc.** are not always properly equipped in the bathroom environment to allow people with disabilities to maintain a safe and independent lifestyle.*

Surveys of qualified personnel have highlighted the need to invest in this area.

Alpi is committed to doing this with the assistance of experts to find innovative and correct solutions.



 **mobilità ridotta**
reduced mobility

tecnologia termostatica - sicurezza totale
thermostatic technology - total safety

Azienda leader nella produzione di miscelatori termostatici, da sempre attenta al concetto di sicurezza nell'ambiente bagno, propone oggi una nuova linea di prodotti dedicati alle **persone con mobilità ridotta**.

*Leading manufacturer of thermostatic mixers, always attentive to the concept of safety in the bathroom environment, is now offering a new product range dedicated to **people with reduced mobility**.*



 **SECUREstop**
Pulsante per il blocco della temperatura a 38°
Button to set the temperature at 38°

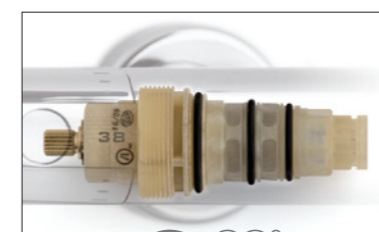

 **SELFcontrol**

Garantisce maggiore sicurezza mantenendo la temperatura dell'acqua costante con più precisione.

This ensures greater safety while maintaining the water temperature constant with more precision.



 **PROtherm**

I miscelatori termostatici di ultima generazione hanno una protezione in più. Anche con l'acqua molto calda, non scottano mai esternamente, grazie alla tecnologia  **PROtherm** che mantiene separato il flusso di acqua calda dalla superficie metallica del miscelatore.

*The latest generation of thermostatic mixers have additional protection. Even with very hot water, they never become too outside, thanks to  **PROtherm** technology that keeps the flow of hot water separate from the metal surface of the mixer.*



mobilità ridotta
reduced mobility

materiali d'avanguardia - comfort assoluto
most advanced materials - total comfort

Particolare attenzione nella creazione di forme arrotondate che evitano anche i più piccoli incidenti unita ad un'attenta ricerca di materiali morbidi al tatto e resistenti nello stesso tempo.

Particular attention in the creation of rounded shapes avoiding even the smallest accidents combined with careful selection of materials that are soft to the touch and resistant at the same time.



L'assenza di spigoli garantisce **sicurezza totale**.
 La lunghezza della leva agevola il movimento di apertura e chiusura dell'erogazione dell'acqua.

*The absence of corners ensures **safety**.
 The length of the lever facilitates the movement for turning the water on and off.*

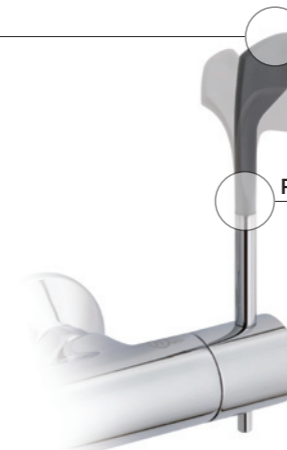

Morbido materiale **antishock**.
 Garantisce sicurezza in caso di urto e prensilità grazie ad un particolare trattamento antiscivolo.

*Soft **anti-shock** material that ensures safety if the part is hit, and easy to grip operation thanks to a non-slip treatment.*

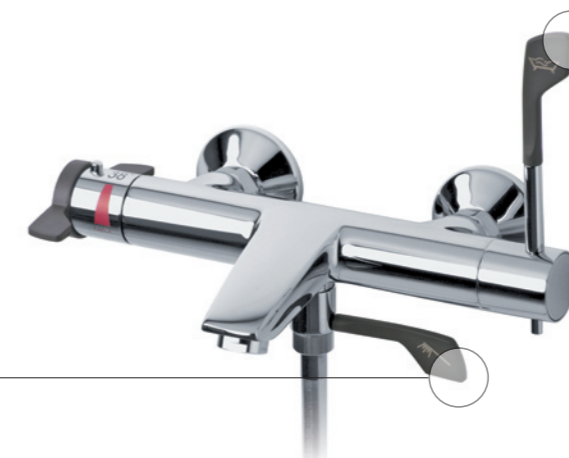

I comandi per scegliere la via di erogazione dell'acqua sono indipendenti tra loro.

Flow controls to operate each water outlet are independent.

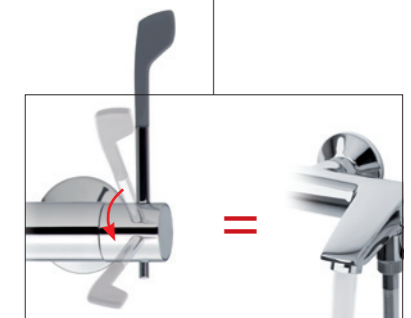

Alle persone che si trovano in una condizione di **permanente disabilità**, occorre aggiungere le persone che si trovano in una condizione "naturale" di **diversa abilità**, quali **bambini, anziani, portatori di traumi non permanenti**.

*In addition to people with a **permanent disability**, it is also necessary to add people who are "naturally" **less able**, such as **children, the elderly, people with non-permanent injuries**.*



 **mobilità ridotta**
reduced mobility

ricerca e tecnologia - sinonimo di garanzia
research and technology - a synonym of guarantee

Il **comando demoltiplicato** favorisce la rotazione rendendo leggero il gesto e aumenta la precisione dell'impostazione della temperatura. La doppia leva agevola notevolmente la rotazione in entrambi i sensi. Ai fondamentali aspetti di **sicurezza** e **comfort** si affiancano i concetti di **igiene** e di **gamma**.

*The **double-active** control facilitates rotation, helping easy to turn movements and expanding precision of temperature setting. The fundamental aspects of **safety** and **comfort** are complimented by the concepts of **hygiene** and **full range**.*



HIGHvisibility

Le serigrafie sono molto evidenti e facili da distinguere; studiate appositamente per guidare la corretta impostazione della temperatura.

The screen printing is very clear and easy to distinguish, especially designed to guide correct temperature setting.

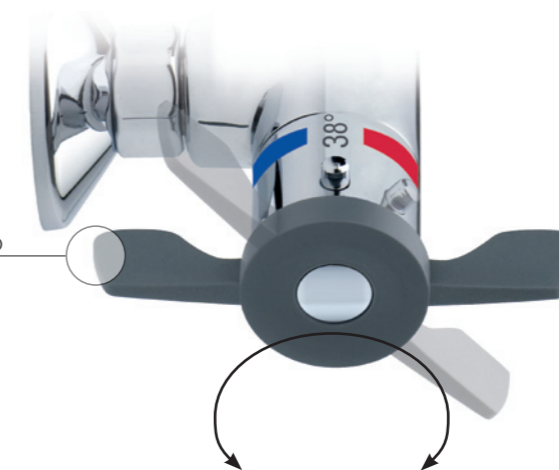
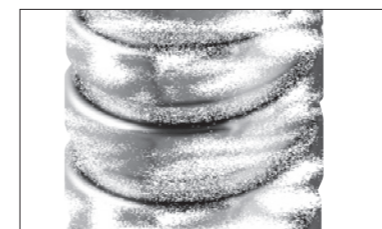

Patented®

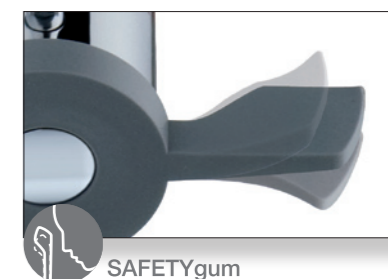

SAFETYgum

Morbido materiale **antishock**. Garantisce sicurezza in caso di urto e prensilità grazie ad un particolare trattamento antiscivolo.

*Soft **anti-shock** material that ensures safety if the part is hit, and easy to grip operation thanks to a non-slip treatment.*



 FLEXeco

Flessibile in gomma liscia, senza spirali, risulta facilmente pulibile e non permette il deposito del calcare e sedimento di batteri.

*The **hose in smooth rubber hose**, without spirals, is easy to clean and prevents limescale deposits and risk of bacteria.*



 **mobilità ridotta**
reduced mobility

ricerca e tecnologia - sinonimo di garanzia
research and technology - a synonym of guarantee

Nulla è lasciato al caso ma realizzato nel pieno rispetto delle persone che va ben oltre le barriere delle normative.
Una vasta gamma lavabo completa di tutte le agevolazioni: altezza maggiorata, canna girevole, canna girevole con doccetta shut-off.

*Nothing is left to chance while everything is manufactured with full respect for people that goes beyond the barriers of regulations.
A wide range of highly functional products for the basin: increased height, swivel spout, swivel spout with shut-off handset.*



HOTlimited

Tutti i miscelatori monocomando sono dotati di cartuccia con limitatore di temperatura.

All single lever mixers are equipped with a ceramic discs cartridge with temperature control.

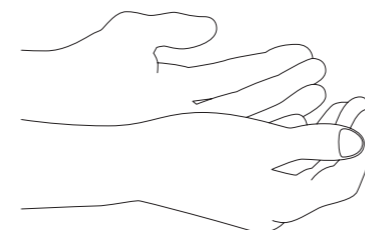

L'altezza maggiore della bocca di erogazione del lavabo consente di adagiare comodamente le mani sotto l'acqua.

The increased height of the spout allows to easily lay the hands under the water.

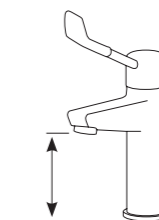

H 110 mm
lavabo
altezza maggiorata
*higher spout
single lever mixer*

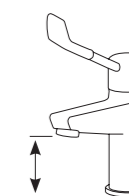

H 80 mm
lavabo
tradizionale
*conventional
single lever mixer*



mobilità ridotta
reduced mobility

Una gamma vasta e completa che agevola e soddisfa tutte le esigenze.
An extensive and complete range to meet safety and functional needs in all environments.



MR 67155 CR
termostatico doccia esterno,
leva lunga mobilità ridotta
*exposed thermostatic shower mixer,
easy-to-use long lever*



MR 67106 CR
termostatico vasca esterno,
leva lunga mobilità ridotta
*exposed thermostatic bath shower mixer,
easy-to-use long lever*



MR 67161 CR
termostatico doccia incasso
con rubinetto regolazione portata,
leva corta mobilità ridotta
*concealed thermostatic shower valve
with stop cock, easy-to-use short lever*



MR 67165 CR
termostatico doccia incasso con 2 rubinetti
regolazione portata, leva corta mobilità ridotta
*concealed thermostatic shower valve
with 2 stop cocks, easy-to-use short lever*



MR 672151 CR
colonna doccia termostatica,
leva lunga mobilità ridotta,
soffione ø 200 mm, doccia monogetto
*thermostatic shower column,
easy-to-use long lever, ø 200 mm
shower head, one spray handset*



MR 674151 CR
colonna vasca/doccia termostatica,
leva lunga mobilità ridotta,
soffione ø 200 mm, doccia monogetto
*thermostatic bath/shower column,
easy-to-use long lever, ø 200 mm
shower head, one spray handset*



MR 67176 CR
monocomando lavabo,
leva lunga mobilità ridotta, scarico 1 1/4"
*single-lever basin mixer, easy-to-use
long lever, 1 1/4" pop up waste*

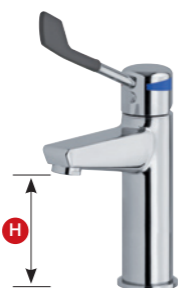

MR 67177 CR
monocomando lavabo alto,
h.110 mm, leva lunga mobilità ridotta
*single-lever high basin mixer,
h.110 mm, easy-to-use long lever*

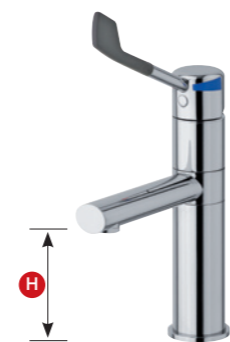

MR 67182 CR
monocomando lavabo alto, h.110 mm,
leva lunga mobilità ridotta, bocca girevole
*single-lever high basin mixer, h.110 mm,
easy-to-use long lever, swivel spout*



MR 67178 CR
monocomando lavabo alto,
h.110 mm, leva lunga mobilità ridotta,
bocca girevole, doccetta laterale multiuso
*single-lever high basin mixer,
h.110 mm, easy-to-use long lever,
swivel spout, multipurpose handset*



MR 67276 CR
termostatico lavabo, leva corta
mobilità ridotta, scarico 1 1/4"
*thermostatic basin mixer, easy-to-use
short lever, 1 1/4" pop up waste*

MR 67276 CR/S
termostatico lavabo, leva corta
mobilità ridotta, senza scarico
*thermostatic basin mixer, easy-to-use
short lever, without pop up waste*



CD 60103 CR
colonna doccia, deviatore integrato,
soffione ø 200 mm, doccia monogetto
*shower column, integrated diverter,
ø 200 mm shower head, one spray handset*



MR 67282 CR
monocomando lavello, leva lunga
mobilità ridotta, bocca girevole
*single-lever sink mixer, easy-to-use
long lever, swivel spout*



MR 67273 CR
termostatico lavello,
leva corta mobilità ridotta
*thermostatic sink mixer,
easy-to-use short lever*



MR 67250 CR
termostatico lavello a muro,
leva lunga mobilità ridotta
*thermostatic sink mixer,
wall mounted, easy-to-use long lever*



DC 042
doccia monogetto anticalcare
one spray anti-scale handset

SM 016
supporto doccia, ABS
ABS shower bracket

FL 120
flessibile doccia "flexeco" PVC metallizzato
150 cm 1/2"Fx1/2"F zigrinato/conico
*"flexeco" shower hose silver PVC,
150 cm 1/2" F x 1/2" F knurled/conical nuts*



BD 011
braccio doccia 350 mm G1/2"
shower arm 350 mm G1/2"

SF052
soffione doccia ø 200 mm, anticalcare, ABS
shower head ø 200 mm, anti-scale, ABS



KI037
kit saliscendi, asta 60 cm,
doccia monogetto anticalcare,
flessibile "flexeco" PVC 150 cm
*slide rail kit, 60 cm tube,
one spray anti-scale handset,
"flexeco" PVC shower hose 150 cm*



 **mobilità ridotta**
reduced mobility

sicurezza totale per tutta la famiglia
total safety for the whole family

Easy Living

